

SP accessories



1. General description	3
2. Electrical accessories	4
Note: Similar Android and iOS-based devices may work as well, but Grundfos does not support these devices.	6
CUE frequency converter.	7
CIU communication interface units	10
Motor starters for MS402 and MS 4000 CSIR/CSCR motors	11
PR 5714 with Pt100 sensor	11
MS motor cables	13
Submersible drop cable	15
Submersible drop cables with plug	15
Cable clips	16
Cable termination kit with plug for MS4000 and MS402	16
Cable termination kit, type KM	17
Cable termination kit, types M0 to M4	18
3. Mechanical accessories	19
Connecting pieces / Adaptors	19
4. Flow sleeves	21
5. Flow sleeve, standard version EN 1.4301/AISI 304	22
6. Flow sleeve SP-G EN 1.4301/AISI 304	28
7. Flow sleeve, R-version, EN 1.4539/AISI 904L	30
8. Zinc anodes	37
Galvanic cathodic protection	37
Position of anode strings on motors.	38
Maintenance	38
Product range	39
Anode strings on motors	43
9. Cable sizing	44
Cables	44
Calculation of the power loss	45
10. Table of head losses	47
Head losses in ordinary water pipes	47
Head losses in plastic pipes.	48
11. Grundfos Product Center	49

1. General description

This data booklet contain information on SP accessories.

For pump related information see pump data booklets:



SP 50 Hz Data Booklet

<http://net.grundfos.com/qr/i/V7165881>



SP 60 Hz Data Booklet

<http://net.grundfos.com/qr/i/V7013316>

For accessory related mounting instructions see quick guides:



Zinc Anode Quick guide

<http://net.grundfos.com/qr/i/98445638>



Flow sleeves Quick guide

<http://net.grundfos.com/qr/i/97759492>



Pt 100 / Pt 1000 Quick guide

<http://net.grundfos.com/qr/i/98445663>

2. Electrical accessories

MP 204 motor protector



Fig. 1 MP 204 motor protector

MP 204 is an electronic motor protector designed for the protection of an asynchronous motor or a pump.

You cannot use the motor protector in installations where a frequency converter is installed.

The motor protector operates with two sets of limits:

- a set of warning limits
- a set of trip limits.

If one or more of the warning limits are exceeded, the motor will continue to run, but the warnings will appear in the display of the motor protector.

Some values only have a warning limit.

You can read out the warning with Grundfos GO.

If one of the trip limits is exceeded, the trip relay will stop the motor. At the same time, the signal relay is operating to indicate that the limit has been exceeded.

Applications

You can use MP 204 as a stand-alone motor protector. You can monitor the motor protector via a Grundfos GENibus.

The motor protector protects the motor primarily by measuring the motor current by means of a true RMS measurement.

The motor protector is designed for single- and three-phase motors. In single-phase motors, the starting and run capacitors are also measured. $\cos \varphi$ is measured in both single- and three-phase systems.

Benefits

The motor protector offers these benefits:

- suitable for both single- and three-phase motors
- dry-running protection
- overload protection
- very high accuracy
- made for submersible pumps.
- monitor motor temperature via motor cable (only motors with tempcon sensor.)

The many monitoring options of the motor protector

The motor protector monitors the following parameters:

- insulation resistance before startup
- temperature (Tempcon, Pt sensor and PTC/thermal switch)
- overload and underload
- overvoltage and undervoltage
- phase sequence
- phase failure
- power factor
- power consumption
- harmonic distortion
- operating hours and number of starts.

Note: Monitoring of motor temperature is not possible when you use single-turn transformers.

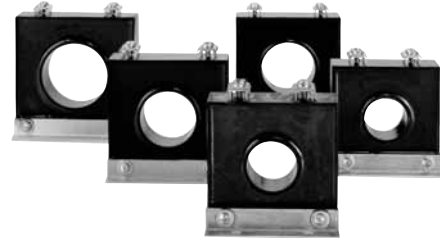

Fig. 2 Single-turn transformers

TM056466 3712

TM03 2033 3505

Product numbers, MP 204

Product	Product number
MP 204	96079927
Single-turn transformers	
Current transformer ratio: 200:5, $I_{max.} = 120$ A	96095274
Current transformer ratio: 300:5, $I_{max.} = 300$ A	96095275
Current transformer ratio: 500:5, $I_{max.} = 500$ A	96095276
Current transformer ratio: 750:5, $I_{max.} = 750$ A	96095277
Current transformer ratio: 1000:5, $I_{max.} = 1000$ A	96095278

Technical data, MP 204

Enclosure class	IP20
Ambient temperature	-20 - 60 °C
Relative humidity	99 %
Voltage range	100-480 VAC
Current range	3-999 A
Frequency	50 to 60 Hz
IEC trip class	1-45
Special Grundfos trip class	0.1 - 30 s
Voltage variation	- 25 %/+ 15 % of rated voltage
Approvals	EN 60947, EN 60335, UL/CSA 508
Marking	CE, cUL, C-tick
Consumption	Maximum 5 W
Plastic type	Black PC/ABS

Electrical data, MP 204

	Measuring range	Accuracy	Resolution
Current without external current transformers	3-120 A	± 1 %	0.1 A
Current with external current transformers	120-999 A	± 1 %	1 A
Phase-to-phase voltage	80-610 VAC	± 1 %	1 V
Frequency	47-63 Hz	± 1 %	0.5 Hz
Power	0-1 MW	± 2 %	1 W
Power factor	0 - 0.99	± 2 %	0.01
Energy consumption	0-4 x 10 ⁹ kWh	± 5 %	1 kWh

For further information about MP 204 and pump controls, see the literature available on <https://product-selection.grundfos.com> (Grundfos Product Center).

Grundfos GO



The pump is designed for wireless communication with the Grundfos GO app which communicates with the pump via radio communication.

Note: The radio communication between the pump and Grundfos GO is encrypted to protect against misuse.

The Grundfos GO app is available from Apple App Store and Android market.

The Grundfos GO app must be used in conjunction with one of the following mobile interface devices:

Mobile interface	Product number
Grundfos MI 202	98046376
Grundfos MI 204	98424092
Grundfos MI 301	98046408

The Grundfos GO concept replaces the Grundfos R100 remote control. This means that all products supported by the R100 are supported by Grundfos GO. For function and connection to the pump, see separate installation and operating instructions for the desired type of Grundfos GO setup.

Mobile interface

The available mobile interface devices are described in the following.

MI 202 and MI 204

MI 202 and MI 204 are add-on modules with built-in infrared and radio communication. MI 202 can be used in conjunction with Apple devices with 30-pin connector (iPhone 4, 4S and iPod touch 4G).

MI 204 can be used in conjunction with Apple devices with lightning connector (iPhone 5, 5C, 5S and iPod touch 5G, and newer IOS devices).



Fig. 3 MI 202 and MI 204

TM05 3887 1612 - TM05 7704 1513

The following are supplied with the product:

- Grundfos MI 202 or 204
- sleeve
- quick guide
- charger cable.

MI 301

MI 301 is a module with built-in infrared and radio communication. MI 301 must be used in conjunction with an Android or iOS-based Smartphone with a Bluetooth connection. MI 301 has a rechargeable Li-ion battery that you must charge separately.



TM05 3887 1612

Fig. 4 MI 301

The following are supplied with the product:

- Grundfos MI 301
- sleeve
- battery charger
- quick guide.

Supported units??ABUN:Skal listen opdateres med nyere modeller?

Make	Model	Operating system	MI 202	MI 204	MI 301
Apple	iPod touch 4G	iOS 5.0 or later	•	-	•
	iPhone 4, 4S		•	-	•
	iPod touch 5G and newer versions	iOS 6.0 or later	-	•	•
iPhone 5, 5C, 5S and newer versions	-		•	•	
HTC	Desire S	Android 2.3.3 or later	-	-	•
	Sensation	Android 2.3.4 or later	-	-	•
Samsung	Galaxy S II	Android 2.3.4 or later	-	-	•
	Galaxy Nexus	Android 4.0 or later	-	-	•
LG	Google Nexus 4	Android 4.2 or later	-	-	•

Note: Similar Android and iOS-based devices may work as well, but Grundfos does not support these devices.

CUE frequency converter



GrA4404 3407

Fig. 5 The CUE range

Grundfos CUE is a series of external frequency converters designed for speed control of a wide range of Grundfos pumps.

When a CUE is installed, the motor requires no further overload protection. If overheating protection of motor windings is desired, Pt100/1000 together with MCB 114 sensor input module can provide this protection.

Note: If the motors have built in Tempcon sensor, this sensor will be disconnected when exposed to frequency convert drive. A internal fuse in the motor blows and cannot be replaced. The motor will work without the sensor, but it is not possible to restore tempcon functionality.

CUE offers quick and easy setup and commissioning compared to a standard frequency converter because of the startup guide. Simply key in application-specific variables such as motor data, pump family, control function (for example constant pressure), sensor type and setpoint, and CUE automatically sets all necessary parameters.

CUE enables gentle pumping and thereby protects the water reservoir and the rest of the distribution system, as water hammer can be avoided by adjusting ramp times up and down.

Overview of the CUE range

Supply voltage [V]	Power range [kW]						
	0.55	0.75	1.1	7.5	11	45	250
3 x 525-690					•	•	•
3 x 525-600		•	•	•			
3 x 380-500	•	•	•	•	•	•	•
3 x 200-240		•	•	•	•	•	
1 x 200-240			•	•			

CUE is available in two enclosure classes:

- IP20/21
- IP54/55.

RFI filters

To meet the EMC requirements, CUE comes with the following types of built-in radio frequency interference filter (RFI).

Voltage [V]	Typical shaft power, P2 [kW]	RFI filter type	Application
1 x 200-240	1.1 - 7.5	C1	Domestic
3 x 200-240	0.75 - 45	C1	
3 x 380-500	0.55 - 90	C1	Domestic and industry
	110 - 250	C2	
3 x 525-600	0.75 - 7.5	C3	Industry
3 x 525-690	11 - 25	C3	

Functions

CUE has a wide range of pump-specific functions, such as:

- constant pressure
- constant level
- constant flow rate
- constant temperature
- constant curve.

CUE features

- Startup guide
CUE incorporates an innovative startup guide for the general setting of CUE including the setting of the correct direction of rotation. The startup guide is started the first time CUE is connected to the power supply.
- Check of direction of rotation.
- Duty and standby operation.
- Dry-running protection.
- Low-flow stop function.

Sensors

The following sensors can be used in connection with CUE. All sensors are with 4-20 mA output signal.

- pressure sensors, up to 25 bar
- temperature sensors
- differential-pressure sensors
- differential-temperature sensors
- flowmeters
- potentiometer box for external setpoint setting.

Accessories for CUE

Grundfos offers various accessories for CUE.

MCB 114 sensor input module

MCB 114 offers additional analog inputs for CUE:

- 1 analog input, 0/4-20 mA
- 2 inputs for Pt100 and Pt1000 temperature sensors.

Output filters

Output filters protect the motor from overvoltage and increased operating temperature. The filters reduce voltage stress on the motor windings and stress on the motor insulation system. The filters also decrease acoustic noise from the frequency converter-driven motor.

Grundfos offers two types of output filters as CUE accessories

- dU/dt filters
- sine-wave filters.

dU/dt filters

dU/dt filters reduce the voltage peaks and dU/dt of the pulses at the motor terminals. The voltage at the motor terminals is pulse-shaped; the motor current has a sine-wave shape without commutation spikes.

Sine-wave filters

Sine-wave filters have a higher degree of filtering, resulting in high reduction of motor insulation stress and elimination of switching acoustic noise from the motor. The motor losses are reduced as the motor is fed with a sine-wave voltage and because the filter eliminates the pulse reflections in the motor cable.

Use of output filters

The table below shows in which cases an output filter is required. From the table, it can be seen if a filter is needed, and which type to use. For MS and MMS motors Grundfos recommend sine-wave filters.

The selection depends on these factors:

- pump type
- motor cable length
- the required reduction of acoustic noise from the motor.

Pump type	Motor type	dU/dt filter [motor cable length]	Sine-wave filter [motor cable length]
SP with up to 400V motor	MS, MMS	0-100 m	0-300 m
SP with above 400V motor	MS, MMS	NA	0-300 m

Cables used in CUE installations

Note: When CUE is installed in connection with SP pumps, we distinguish between two types of installation:

- installation in EMC-insensitive sites. See fig. 6.
- installation in EMC-sensitive sites. See fig. 7.

The two types of installation are different when it comes to the use of screened cable.

Note: Drop cables are always unscreened.

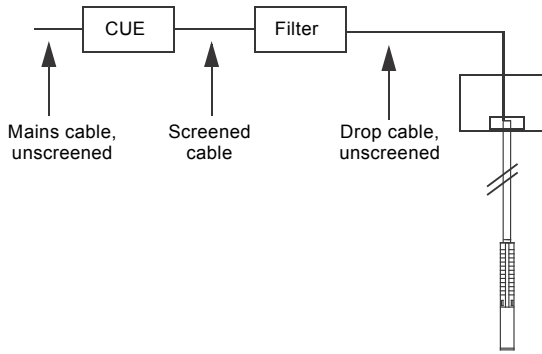

TM04 4296 1109

Fig. 6 Example of installation in EMC-insensitive sites

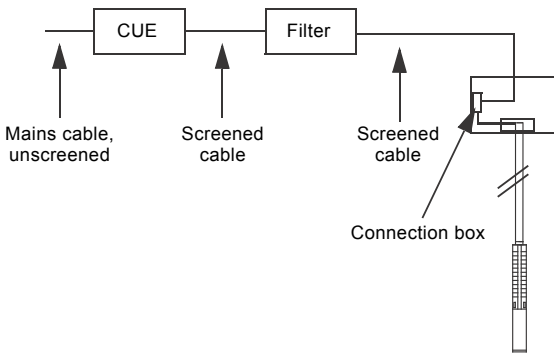

TM04 4295 1109

Fig. 7 Example of installation in EMC-sensitive sites

Screened cables are required in those parts of the installation where the surroundings must be protected against EMC.

CUE is the right choice of frequency converter in SP installations as it meets all basic issues. CUE has a pre-installed startup guide which takes the installer through all the necessary settings.

The table below shows the different issues to be considered when using frequency converters in SP installations.

Issues to be considered	Explanation
Ramp (up and down): Maximum 3 seconds.	The journal bearings must be lubricated in order to limit wear and overheating of windings.
Use temperature monitoring by Pt sensor.	Overheating of the motor => low insulation resistance => sensitive to voltage peaks. Note: Tempcon sensors do not work with frequency converter operation.
Reduce peak voltages (maximum 800 V peaks).	Never exceed peak voltages of 850 V at motor leads.
For MS and MMS, we recommend to use motors with 10 % extra in given duty point. For MMS, always use motors wound PE2-PA.	Grundfos CUE with output filter is a safe solution.
Remember output filter.	Cables act as an amplifier => measure peaks at the motor.
Rise time (dU/dt) must be limited to a maximum of 1000 V/µs. It is determined by the equipment in CUE.	Time between switches is an expression of losses, so in the future, we might have to exceed the limit of 1000 V/µs. The solution is not higher insulation of the motor, but filter in the output from CUE.
Constant operation at minimum 30 Hz.	Too low speed => low flow and thereby poor lubrication of journal bearings.
Size CUE in respect of the current, not the power output.	Can end up with a too small CUE.
Size cooling provision for stator tube at duty point with lowest flow rate.	Flow minimum m/s along the stator housing must be considered.
Ensure that the pump is used within the range of the pump curve.	Focus on outlet pressure and sufficient Net Positive Suction Head, as vibrations will "kill" the motor.

CIU communication interface units



GrA6118 3908

Fig. 8 Grundfos CIU communication interface unit

The Communication Interface Unit (CIU) enables data communication via open and interoperable networks, such as:

- Profibus DP,
- Profinet
- Modbus RTU,
- Modbus TPC
- LonWorks,
- BACnet MS/TP,
- BACnet/IP
- GSM/GPRS
- Grundfos Remote Management (GRM) for complete control of pump systems.

Applications

The range of Grundfos CIU communication interface units offers ease of installation and commissioning as well as user-friendliness. All units are based on standard functional profiles for an easy integration into the network.

The CIU units enable communication of operating data, such as measured values and setpoints, between pumps and PLCs, SCADA system and building management system.

Benefits

CIU offers these benefits:

- open communication standards
- complete process control
- one concept for Grundfos products
- 24-240 VAC/DC power supply in CIU modules
- simple configuration and easy to install
- prepared for DIN rail or wall mounting.

For data communication between an SP pump and a main network, a CIU unit together with a CUE frequency converter or an MP 204 motor protector is required.



TM05 5456 3712 - GrA4 412 3307

Fig. 9 MP 204 motor protector and CUE frequency converter

Fieldbus support for these products is shown in the following table:

CIU unit	Fieldbus protocol	CUE	MP 204
CIU 100	LonWorks	•	-
CIU 150	Profibus DP	•	•
CIU 200	Modbus RTU	•	•
CIU 250	GSM/GPRS	•	•
CIU 270/271*	GRM	•	•
CIU 300	BACnet MS/TP	•	-
CIU 500	Profinet Modbus TPC BACnet/IP GRM IP**	•	•

* Grundfos Remote Management (GRM) is an easy-to-install low-cost solution for wireless monitoring and management of Grundfos products.

** Requires external 3G/4G modem

CIU Product numbers

CIU unit	Fieldbus protocol	Product number
CIU 100	LonWorks	96753735
CIU 150	Profibus DP	96753081
CIU 200	Modbus RTU	96753082
CIU 250*	GSM/GPRS	96787106
CIU 270*	GRM	98176136
CIU 271*	GRM	96898819
CIU 300	BACnet MS/TP	96893769
CIU 500	Profinet Modbus TPC BACnet/IP GRM IP**	96953894

* Antenna not included. See below.

Antennas for CIU 250 and 270/271

Description	Product number
Antenna for roof	97631956
Antenna for desk	97631957

Motor starters for MS402 and MS 4000 CSIR/CSCR motors

Applications

SA-SPM control boxes are used as starting units for 200-240 V motors.



TM06 4358 2015

Fig. 10 Motor starter for MS 402 and MS 4000

Product numbers

	Product number	CS [μF]	CR [μF]
Motor starter - CSIR - 0.37 kW	98582272	65	-
Motor starter - CSIR - 0.55 kW	98582277	98	-
Motor starter - CSIR - 0.75 kW	98582295	119	-
Motor starter - CSCR - 1.1 kW,	98582296	143	40
Motor starter - CSCR - 1.5 kW	98582381	160	50
Motor starter - CSCR - 2.2 kW	98582401	268	60

PSC motor capacitors

The MS 402 and MS 4000 single-phase, 3-wire, PSC motors must be connected to the mains via a motor capacitor that is permanently connected during operation.

Product numbers

Capacitors for MS 402 PSC and MS 4000 PSC		
Capacitor size	Power [kW]	Capacitor
16 iF, 400 V, 50 Hz	0.37	96279800
20 μF, 400 V, 50 Hz	0.55	96279732
30 μF, 400 V, 50 Hz	0.75	96279808
40 μF, 400 V, 50 Hz	1.1	96279810

PR 5714 with Pt100 sensor

PR 5714 with Pt100 sensor offers these features:

- continuous monitoring of the motor temperature
- protection against too high motor temperature.

Protecting the motor against too high motor temperature is the simplest and cheapest way of avoiding that the motor life is reduced. The Pt100 sensor ensures that the operating conditions are not exceeded and indicates when it is time for service of the motor.

Monitoring and protection by means of a Pt100 require the following parts:

- Pt100 sensor
- PR 5714 relay
- cable.









The following temperature limits are preset on delivery:

- 60 °C warning limit
- 75 °C stop limit.

To set the warning limit, observe the temperature at normal operation and add 10 °C. Additionally add 10 °C for stop limit.

Technical data

PR 5714	
Enclosure class	IP65 (fitted in a control panel)
Ambient temperature	-20 °C to +60 °C
Relative humidity	95 % (condensating)
Voltage variation	• 1 x 24-230 VAC ± 10 %, 50-60 Hz • 24-250 VDC ± 20 %
Approvals	UL, DNV
Marking	CE

PR 5714 relay	Voltage	Product number
	24-230 VAC, 50/60 Hz / 24-250 VDC	96913234
GRA3186 0407		
Pt100 sensor, including cable for standard-, N- and R-versions	Cable length [m]	Product number
	20	96913237
	40	96913253
	60	96913256
	80	96913260
	100	96913263
GRA3190 0407		
Staybolt kits for Pt100 in MS 6000	Description	Product number
	Staybolt kit for Pt100/Pt1000. Material: EN 1.4401/AISI 316.	97550639
	Staybolt kit for Pt100. Material: EN 1.4539/AISI 90L.	96803373
GRA3191 0407		
Insertion probe for MMS 10000 and MMS 12000	Description	Product number
	Insertion probe for Pt100/Pt1000 in MMS 10000 and MMS 12000. Material: EN 1.4401/316 (N-version).	96913215
	Insertion probe for Pt100/Pt1000 in MMS 10000 and MMS 12000. Material: EN 1.4539/AISI 904L (R-version)	99298250
TM04 3560 4508		
Pt1000 sensor, including cable	Cable length [m]	Product number
	20	96804042
	40	96804044
	60	96804064
	80	96804065
	100	96804067
TM04 3563 4508		
Staybolt kits for Pt1000 in MS 402 and MS 4000	Description	Product number
	Staybolt kit for Pt1000. Material: EN 1.4401/AISI 316.	98090278
	Staybolt kit for Pt1000. Material: EN 1.4539/AISI 904.	98090341
TM05 3694 1612		
Extension kit for sensor cable for Pt100/Pt1000	Description	Product number
	Extension kit for Pt100/Pt1000 sensor cable. For watertight shrink-joining of the sensor cable. Extra sensor cable must be ordered separately.	99039717
TM00 7885 (1m)		
Sensor cable	Description	Product number
	Drop cable for extension: 4#1 mm ² Mention length when ordering. Maximum recommended length: 350 m.	00RM5271
TM00 7882 2296		

MS motor cables

See the following tables for information about additional motor cables for the MS 402, MS 4000, and MS 6000 range.

Drinking water approval

TML-B cables are drinking water compatible with ACS and KTW approvals.

For more information on sizing cables, see [Length of motor](#) on page 43.

Note: The maximum permissible voltage drop in the motor cable is 3 %.

Note: Always dimension motor cables that are not submerged in the pumped liquid as submersible drop cables.

MS 402 three-phase motor cables

TML-B motor cables with EPR outer sheath (ethylene propylene rubber)					
Motor type	Length [m]	Plug steel grade	Cross-section [mm ²]	Plug for drop cable	Product number
MS 402	10	Standard	4 G 1.5	No	00795752
	15				00795753
	20				00795754
	30				00795755
	40				00798890
	50				00795800
	60				98115565
	70				98162757
	80				98162787
	90				98162790
	110				98162804
	120				98163288
MS 402	1.7	Standard	4 G 1.5	Yes	00795712
	2.5				00795739
	5				00798891
	10				00798892

MS 4000 three-phase motor cables

TML-B motor cables with EPR outer sheath (ethylene propylene rubber)					
Motor type	Length [m]	Cross-section [mm ²]	Plug for drop cable	Product numbers	
				Plug steel grade standard	Plug steel grade R
MS 4000	10	4 G 1.5	Yes	00795620	00795861
	20			00795621	00795862
	30			00795622	00795863
	40			00795623	00795864
	50			00795624	00795865
	60			00795625	00799924
	70			00795626	00799923
MS 4000	10	4 G 1.5	No	00795632	00795873
	20			00795633	00795872
	30			00795634	00795871
	40			00795635	00795870
	50			00795636	00795869
	60			00795637	00799926
	70			00795638	00799925
MS 4000	50	4G 2.5		-	96800534
	80			-	97949530
	130			-	96893810
	150			-	96893838
	170			-	96893844

MS 4000 environmental three-phase motor cables

PTFE motor cables with teflon outer sheath				
Motor type	Length [m]	Cross-section [mm ²]	Plug for drop cable	Product numbers
				Plug steel grade R
MS 4000	10	4 G 2.5	No	00795667
	20			00795668
	30			00795669
	40			00795670
	50			00795671
	60			00795672
	70			00795673
	80			00795674
	90			00795675
	100			00795676
	110			96476404
	120			96426909
	200			96432567

MS 6000 three-phase motor cables

TML-B motor cables EPR outer sheath (ethylene propylene rubber)					
Motor type	Length [m]	Cross-section [mm ²]	Plug for drop cable	Product numbers	
				Plug steel grade N	Plug steel grade R
MS 6000	10	4G 6.0		96164211	96300113
	20			96164212	96300115
	30			96164213	96300117
MS 6000	10	4G 10.0	No	96164215	96300124
	20			96164216	96300126
	30			96164217	96300128
	40			-	96300129
	50			96164218	96300130

Submersible drop cable

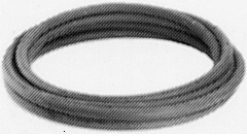
Product	Description	Number of leads and nominal cross-section [mm ²]	Outer cable diameter min./max. [mm]	Weight [kg/m]	Product number
 <p>Suitable for these applications:</p> <ul style="list-style-type: none"> • continuous application in groundwater and potable water (approved for potable-water applications) • connection of electrical equipment, such as submersible motors • installation depths up to 600 metres and average loads. <p>Insulation and sheath of special EPR-based elastomer materials adapted to applications in water.</p> <p>Maximum permissible water temperature: 70 °C. Maximum permissible lead service temperature: 90 °C.</p> <p>Further cable sizes are available on request.</p> <p style="writing-mode: vertical-rl; transform: rotate(180deg);">TM00 7882 2296</p>		1 x 25	12.5 / 16.5	0.410	00ID4072
		1 x 35	14.0 / 18.5	0.560	00ID4073
		1 x 50	16.5 / 21.0	0.740	00ID4074
		1 x 70	18.5 / 23.5	1.000	00ID4075
		1 x 95	21.0 / 26.5	1.300	00ID4076
		1 x 120	23.5 / 28.5	1.650	00ID4077
		1 x 150	26.0 / 31.5	2.000	00ID4078
		1 x 185	27.5 / 34.5	2.500	00ID4079
		4G1.5	10.5 / 13.5	0.190	00ID4063
		4G2.5	12.5 / 15.5	0.280	00ID4064
		4G4.0	14.5 / 18.0	0.390	00ID4065
		4G6.0	16.5 / 22.0	0.520	00ID4066
		4G10	22.5 / 24.5	0.950	00ID4067
		4G16	26.5 / 28.5	1.400	00ID4068
		4G25	32.0 / 34.0	1.950	00ID4069
		4G35	33.0 / 42.5	2.700	96432949
		4G50	38.0 / 48.5	3.600	96432950
		4G70	43.0 / 54.5	4.900	96432951

Submersible drop cables with plug

Submersible drop cable with plug to MS402 MS4000 with 2 plug motor cable.

Product	Cable length [m]	Product number
	4x1.5 mm ²	
	15	0079H001
	20	0079H002
	25	0079H003
	30	0079H004
	40	0079H005
	50	0079H006
	70	0079H008
	100	0079H009
	4x2.5mm ²	
	15	0079H021
	20	0079H022
	25	0079H023
	30	0079H024
	40	0079H025
	50	0079H026
	70	0079H028
	100	0079H029
	4x4mm ²	
	15	0079H041
	20	0079H042
	25	0079H043
	30	0079H044
	40	0079H045
	50	0079H046
	70	0079H048

Cable clips

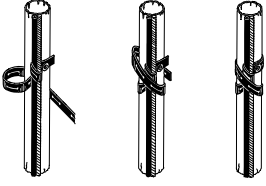
Product	Description	Product number
	<p>For fastening of cable and straining wire to the riser pipe. The clips must be fitted every 3 metres. One set for approximately 45 m riser pipe.</p> <ul style="list-style-type: none"> • 16 cable buttons. • 7.5 m rubber band. 	00115016

TM00 1369 5092

Cable termination kit with plug for MS4000 and MS402

Product	Description	Version	Product number	
			N-version	R-version
	<p>For watertight joining of motor cable and submersible drop cable in an acrylic tube filled with resin. Used for both single- and multi-core cables during installation of submersible pumps. 24 hours of hardening is required.</p>	<p>For cables up to 4 x 2.5 mm²</p> <p>For cables up to 4 x 6 mm²</p>	00799901	00799955
			00799902	00799918

TM00 7883 2296

Cable termination kit, type KM

For instruction on how to make the cable termination between motor cable and drop cable, see the KM quick guide available on <http://net.grundfos.com/qr/i/V7065924> (Grundfos Product Center).

Grundfos recommendation

First termination of motor cable and drop cable should be placed maximum 1/2 meter above the pump end.

Do not attempt to join two cables that have a larger cross section span than stated in the following table.

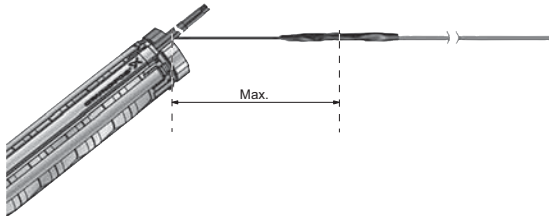

TM06 9876 0817

Motor cable [mm ²]	Drop cable, maximum increase per step. [mm ²]			
2,5	6,0	16,0	50,0	-
6,0	16,0	35,0	70,0	150,0
10,0	25,0	50,0	120,0	240,0
16,0	50,0	120,0	240,0	-
25,0	70,0	150,0	240,0	-
35,0	70,0	150,0	240,0	-
50,0	120,0	240,0	-	-
70,0	150,0	240,0	-	-

Possible cable termination		Content of kit	Motor cable [mm ²]	Drop cable [mm ²]	Number of leads	Product number
Motor cable	Drop cable					
			KM kits with pressed connections:			
			1.5 - 6	1.5 - 6	4	00116251
			6-16	6-16	4	00116252
			10-25	10-25	4	00116255
			KM kits with screw connectors:			
			6-35	6-35	4	96636867
			25-70	25-70	4	96636868

Possible cable termination		Content of kit	Motor cable [mm ²]	Drop cable [mm ²]	Number of leads	Product number
Motor cable	Drop cable					
			KM kits with pressed connections:			
			1.5 - 6	1.5 - 6	4	00116257
			6-16	6-16	4	00116258
			10-50	10-50	4	96637330
			16-70	16-70	4	96637332
			1.5 - 6	1.5 - 6	3	00116253
			10-25	10-25	3	00116254
			10-50	10-50	3	96637318
			16-70	16-70	3	96637331

Possible cable termination		Content of kit	Motor cable [mm ²]	Drop cable [mm ²]	Number of leads	Product number
Motor cable	Drop cable					
			KM kits with pressed connections:			
			10-70	10-70	1	96828296
			32-120	32-120	1	00116256
			KM kits with screw connectors:			
			70-240	70-240	1	96637279

Note: A KM termination kit for single leads only consist of material for one connection. When ordering, keep in mind how many kits are needed for a complete cable termination.

Cable termination kit, types M0 to M4

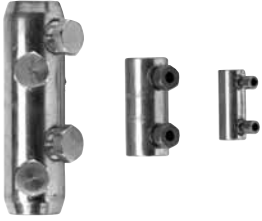
Product	Description	Version			
		Type	Diameter of cable joint [mm]	Outer cable diameter [mm]	Product number
	For watertight joining of motor cable and submersible drop cable. The joint is encapsulated by the glue which is part of the kit.	M0	Ø40	Ø6 - Ø15	ID8903
		M1	Ø46	Ø9 - Ø23	ID8904
		M2	Ø52	Ø17 - Ø31	ID8905
		M3	Ø77	Ø26 - Ø44	ID8906
		M4	Ø97	Ø29 - Ø55	91070700
	Accessories for cable kits M0 to M4. Screw connectors only.		Cross-section of leads [mm²]	Number of connectors	Product number
			6-25	4	96626021
			16-95		96626022
			35-185		96626023
			70-240		96626028

3. Mechanical accessories

Connecting pieces / Adaptors

The tables below show the range of connecting pieces for connection of thread-to-flange and thread-to-thread.

Thread-to-flange (standard flange to EN 1092-1)

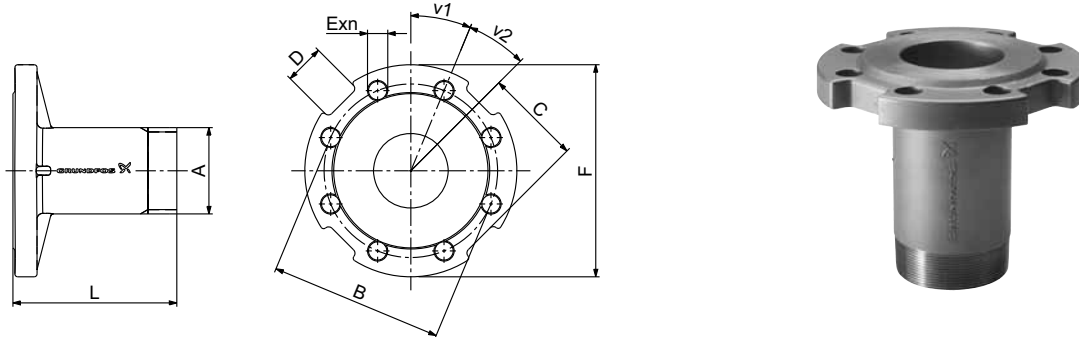

TM01 2396 4508 - GrA2552 3706

Fig. 11 Dimensional sketch and photo of the connecting piece thread-to-flange

Type	Pump outlet	Connecting piece	Thread-to-flange										Product number	
			A	Dimensions [mm]						v1	v2	n	EN 1.4308	EN 1.4517
				B	C	D	E	F	L					
SP 17	Rp 2 1/2	R 2 1/2 → DN 50 PN 16/40	R 2 1/2	125	65	40	∅19	∅165	170	30	30	4	00120125	00120911
		R 2 1/2 → DN 65 PN 16/40	R 2 1/2	145	71	30	∅19	∅185	170	22.5	22.5	8	00120126	00120910
		R 2 1/2 → DN 80 PN 16/40	R 2 1/2	160	82.5	40	∅19	∅200	170	22.5	22.5	8	00120127	00120909
SP 30 SP 46 SP 60	Rp 3	R 3 → DN 65 PN 16/40	R 3	145	71	30	∅19	∅185	170	22.5	22.5	8	00130187	00130920
		R 3 → DN 80 PN 16/40	R 3	160	82.5	40	∅19	∅200	170	22.5	22.5	8	00130188	00130921
		R 3 → DN 100 PN 40	R 3	180/190	100	40	∅19/∅23	∅235	170	22.5	22.5	8	00130189	00130922
		R 3 → DN 100 PN 16	R 3	180/190	100	40	∅19/∅23	∅235	180	22.5	22.5	8	00130210	00130867
SP 46 SP 60	Rp 4	R 4 → DN 100 PN 16	R 4	180	100	40	∅19	∅235	180	22.5	22.5	8	00140077	00140737
		R 4 → DN 100 PN 40	R 4	190	100	40	∅23	∅235	180	22.5	22.5	8	00140071	00140577
SP 77 SP 95	Rp 5	R 5 → DN 100 PN 16	R 5	180	82	35	∅19	∅220	195	22.5	22.5	8	00160159	00160657
		R 5 → DN 100 PN 40	R 5	190	82	35	∅23	∅235	195	22.5	22.5	8	00160148	00160646
		R 5 → DN 125 PN 16	R 5	210	99	37	∅19/∅28	∅250	195	22.5	22.5	8	00160157	00160655
		R 5 → DN 125 PN 40AAA	R 5	220	99	37	∅19/∅28	∅270	195	22.5	22.5	8	00160149	00160647
		R 5 → DN 150 PN 16	R 5	240	115	36	∅23	∅285	195	22.5	22.5	8	00160161	00160659
SP 125 SP 160 SP 215	Rp 6	R 6 → DN 150 PN 40	R 5	250	115	36	∅28	∅300	195	22.5	22.5	8	00160150	00160648
		R 6 → DN 125 PN 16	R 6	210	99	36	∅19	∅250	195	22.5	22.5	8	00170170	00170694
		R 6 → DN 125 PN 40	R 6	220	99	36	∅28	∅270	195	22.5	22.5	8	00170159	00170596
		R 6 → DN 150 PN 16	R 6	240	114	36	∅23	∅285	195	22.5	22.5	8	98518437	98518487
		R 6 → DN 150 PN 40	R 6	250	114	36	∅28	∅300	195	22.5	22.5	8	00170160	00170597
		R 6 → DN 200 PN 16	R 6	295	134	36	∅23	∅340	195	15	15	12	00170161	00170598
		R 6 → DN 200 PN 40	R 6	320	151	36	∅31	∅375	200	15	15	12	00170162	00170599

Thread-to-thread

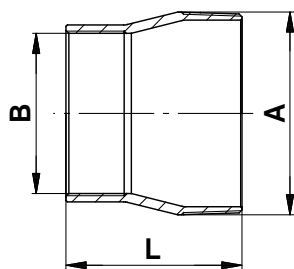

TM01 2397 4508 - TM06 9783 3317

Fig. 12 Dimensional sketch and photo of a connecting piece thread-to-thread

Type	Pump outlet	Connecting piece	Dimensions			Product number		
			Thread-to-thread		L [mm]	EN 1.4301	EN 1.4401	EN 1.4539
			A	B				
SP 77 SP 95	Rp 5	R 5 → Rp 4	R 5	Rp 4	121	190063	190585	96917293
		R 5 → Rp 6	R 5	Rp 6	150	190069	190591	96917296
SP 125 SP 160 SP 215	5" NPT	5" NPT → 4" NPT	5" NPT	4" NPT	121	190064	190586	00190964
		5" NPT → 6" NPT	5" NPT	6" NPT	150	190070	190592	00190965
SP 125 SP 160 SP 215	Rp 6	R 6 → Rp 5	R 6	Rp 5	150	200130	200640	00200971
	6" NPT	6" NPT → 5" NPT	6" NPT	5" NPT	150	200135	200645	00200970

4. Flow sleeves

Grundfos offers a complete range of stainless-steel flow sleeves for both vertical and horizontal operation. We recommend flow sleeves for all applications in which motor cooling is insufficient. The result is a general extension of motor life. Flow sleeves are to be fitted in these cases:

- If the submersible pump is exposed to high thermal load such as current unbalance, dry running, overload, high ambient temperature and bad cooling conditions.
- If aggressive liquids are pumped, since corrosion is doubled for every 10 °C the temperature rises.
- If sedimentation or deposits occur around and/or on the motor.

Maximum liquid temperature

The maximum liquid temperature allowed depends on the flow velocity of the liquid past the motor. See the table below.

Grundfos motor	Flow velocity past motor [m/s]	Maximum liquid temperature [°C]
MS 4"	0.15	40
MS 4" T60	0.15	60
MS 6000	0.15	40
MS 6000 T60	1.00	60
MMS 6" with PVC windings	0.15	25
	0.50	30
MMS 6" with PE/PA windings	0.15	45
	0.50	50
MMS 8", 10", 12" rewindable with PVC windings	0.15	25
	0.50	30
MMS 8", 10", 12" rewindable with PE/PA windings	0.15	40
	0.50	45

Note: For MMS 6", 37 kW, MMS 8", 110 kW, and MMS 10", 170 kW, the maximum liquid temperature is 5 °C lower than the values stated in the table above. For MMS 10", 190 kW, the temperature is 10 °C lower.

Note: More information about flow sleeves is available on request.



TM01 0751 2197 - TM01 0750 2197

Fig. 13 Flow sleeves

Example of calculated flow sleeve

The flow sleeve is fitted to the submersible motor so that the liquid passes close by the motor on its way towards the pump suction interconnector, thus ensuring optimum cooling of the motor. See fig. 14.

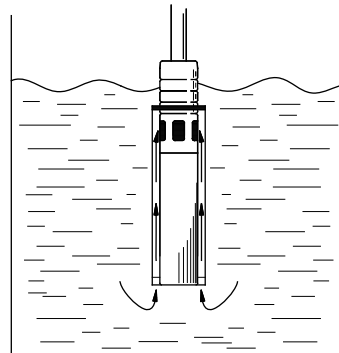

TM01 0509 1297

Fig. 14 Flow sleeve function

The flow sleeve is designed so that the flow velocity past the motor is minimum 0.5 m/s and maximum 3 m/s to ensure optimum pump operating conditions.

Use this formula to calculate flow velocity:

$$V = \frac{Q \times 353}{D^2 - d^2} \text{ [m/s]}$$

Q	m ³ /h	Flow rate
D	mm	Sleeve diameter
d	mm	Motor diameter

Submersible motor diameter

Motor type	Diameter (d) [mm]
MS402	95
MS4000	95
MS6000	139.5
MMS6	144
MMS8000	192
MMS10000	237
MMS12000	286

Over-sized motor

Flow sleeves for pumps with oversize motor and for pumps with non-standard motor are available on request.

5. Flow sleeve, standard version EN 1.4301/AISI 304

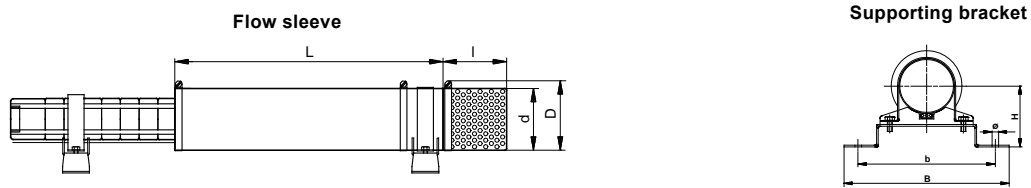

Pump type		Flow sleeve	Strainer	Supporting brackets
50 Hz	60 Hz	Dimensions, d (D) x L Motor type, P2 Weight	Product number Dimensions d x l Weight	Product number Description
SP1A-9 to -28 SP2A-6 to -18 SP3A-6 to -12 SP5A-4 to -8	SP1A-9 to -22 SP2A-6 to -15 SP3A-5 to -10 SP5A-3 to -7	<ul style="list-style-type: none"> d115 (130) x L400 Motor 4", up to 0.75 kW 1.5 kg 	96937110	
SP1A-36 to -57 SP2A-23 to -33 SP3A-15 to -25 SP5A-12 to -17 SP7-1 to -12 SP9-1 to -11 SP11-1 to -11 SP14-1 to -6	SP1A-26 to -39 SP2A-21 to -27 SP3A-14 to -18 SP5A-9 to -11 SP 7 - 1 to 8 SP9-4 to -7 SP11-3 to -7 SP14-1 to -4	<ul style="list-style-type: none"> d115 (130) x 500 Motor 4", up to 2.2 kW 	96937111	96957450 (1 set = 2 brackets) 1.1 kg H100, b185, B220
SP2A-40 to -65 SP3A-29 to -60 SP5A-21 to -60 SP7 - 13 to 42 SP9-13 to -29 SP11-11 to -27 SP14-7 to -23	SP2A-34 to -48 SP3A-24 to -38 SP5A-15 to -39 SP7-8 to -28 SP9-4 to -18 SP11-3 to -18 SP14-5 to -15	<ul style="list-style-type: none"> d115 (130) x 800 Motor 4", up to 5.5 kW 2.5 kg 	96937179	d115 x 117 0.4 kg
SP7 -42 to -59 SP9 -30 to -40 SP11 -28 to -37 SP14 -24 to -31	SP7 -29 to -38 SP9 -19 to -25 SP11 -19 to -24 SP14 -16 to -20	<ul style="list-style-type: none"> d115 (130) x 1000 Motor 4", 7.5 kW (MS 4000) 3.1 kg 	96937204	96958279 (1 set = 2 brackets) 1.4 kg H100, b235, B275
SP5A -52 to -60 SP7 -32 to -59 SP9 -23 to -40 SP11 -21 to -37 SP14-18 to -31	SP5A-39 SP7 -21 to -38 SP9 -17 to -25 SP11 -14 to -24 SP14 -12 to -20	<ul style="list-style-type: none"> d160 (180) x 800 Motor 6", up to 7.5 kW (MS 6000) 4.0 kg 	96937231	98557132 (1 set = 2 brackets) 1.4 kg H125, b185, B220
SP9-41 to -55	SP9-26 to -38	<ul style="list-style-type: none"> d160 (180) x 1000 Motor 6" up to 11 kW (MS 6000) 4,0 kg 	98779730	97942230
SP2A-75 to -90	SP2A-58 SP3A-56	<ul style="list-style-type: none"> d160 (180) x 1000 Motor 4", 7.5 kW (MS 4000) 4.3 kg 	96937205	d160 x 158 0.8 kg 96957525 (1 set = 2 brackets) 1.4 kg H125, b185, B220
SP5A-75 to -85 SP7 - 60 to 100 SP9-56 to -93	SP3A-56 to -75 SP5A-52 SP7 - 41 to -67 SP9-39 to -63	<ul style="list-style-type: none"> d160 (180) x 1000 Motor 6", up to 18.5 kW (MS 6000) 4.9 kg 	96937244	96957529 (1 set = 2 brackets) 1.4 kg H140, b300, B350
SP17-1		<ul style="list-style-type: none"> d145 (160) x 450 Motor 4", up to 2.2 kW (MS 4000) 1.9 kg 	96937139	
SP17-2 SP17-3 SP30-1 to -2	SP17-1 to -2 SP30-1	<ul style="list-style-type: none"> d145 (160) x 550 Motor 4", up to 2.2 kW (MS 4000) 2.2 kg 	96937140	97942214 (1 set = 2 brackets) 2.0 kg H115, b185, B220 for pumps up to 50 kg / 4" up to 7.5 kW
SP17-4 to -7 SP30-3 to -4	SP17-3 to -6 SP30-2 to -3	<ul style="list-style-type: none"> d145 (160) x 800 Motor 4", up to 4 kW (MS 4000) 3.1 kg 	96937180	d145 x 158 0.6 kg
SP17-8 to -13 SP30-5 to -8	SP17-7 to -9 SP30-4 to -5	<ul style="list-style-type: none"> d145 (160) x 1000 Motor 4", 5.5 - 7.5 kW (MS 4000) 3.8 kg 	96937182	

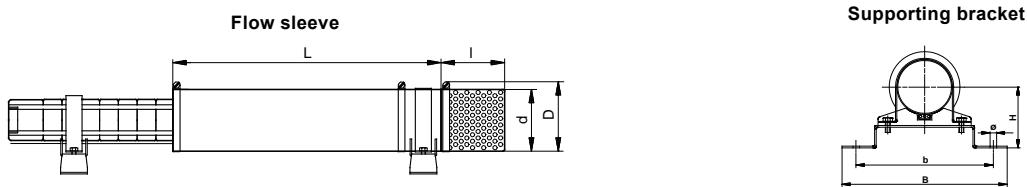

Pump type		Flow sleeve	Strainer	Supporting brackets
50 Hz	60 Hz	Dimensions, d (D) x L Motor type, P2 Weight	Product number Dimensions d x l Weight	Product number Description
SP17-8 to -24 SP30-5 to -15	SP17-5 to -15 SP30-3 to -10	<ul style="list-style-type: none"> d180 (200) x 800 Motor 6", up to 13 kW (MS 6000) 4.0 kg 		
SP17-25 to -40 SP30-16 to -26	SP17-16 to -26 SP30-11 to -17	<ul style="list-style-type: none"> d180 (200) x 1000 Motor 6", up to 22 kW (MS 6000) 4.9 kg 	96937245	96957529 (1 set = 2 brackets) 2.1 kg H140, b300, B350
SP30-27 to -35	SP17-27 to -30 SP30-18 to -23	<ul style="list-style-type: none"> d180 (200) x 1250 Motor 6", 26 to 30 kW (MS 6000) 6.0 kg 	96937249	d180 x 192 0.9 kg
	SP30-24 to -28	<ul style="list-style-type: none"> d180 (200) x 1700 Motor 6", up to 26-37 kW (MMS6) 8.5 kg 	96937313	96957531 (1 set = 3 brackets) 3.1 kg H140, b300, B350
SP17-43 to -53	SP17-33 to -36	<ul style="list-style-type: none"> d200 (220) x 1250 Motor 6", 26-30 kW (MS 6000) Pump in sleeve d154 6.6 kg 	96937246	96957544 (1 set = 2 brackets) 2.3 kg H150, b320, B370
SP17-43 to -60 SP30-39 to -43	SP17-39 to -42	<ul style="list-style-type: none"> d200 (220) x 1700 Motor 6", 26-37 kW (MMS6) Pump in sleeve d154 9.3 kg 	96937315	97942247 d200 x 192 1.0 kg 97695369 (1 set = 3 brackets) 3.2 kg H150, b320, B370
SP17-55 to -60 SP30-39 to -49	SP17-45 to -50	<ul style="list-style-type: none"> d200 (220) x 1700 Motor 6", 37-45 kW (Franklin 6") Pump in sleeve d154 9.3 kg 	96937447	
SP17-45 SP17-48 SP30-46 to -54	SP17-42 to -50 SP30-29 to -39	<ul style="list-style-type: none"> d254 (270) x 1500 Motor 8", 37-55 kW (MMS 8000/Franklin 8") Pump in sleeve d154 9.8 kg 	96937462	97942263 d256 x 325 1.9 kg 96957561 (1 set = 3 brackets) 6.3 kg H200, b380, B430
SP46-1-B SP46-1 SP46-2-BB SP60-1-A SP60-1	SP46-1-B SP46-1-B SP46-1-A SP60-1-B	<ul style="list-style-type: none"> d180 (200) x 550 Motor 4", up to 2.2 kW (MS 402/MS 4000) 2.9 kg 	96937178	
SP46-2 SP46-3-C SP60-2-B SP60-2	SP46-1 SP46-2-AB SP60-1-A SP60-1 SP60-2-BB	<ul style="list-style-type: none"> d180 (200) x 800 Motor 4" 3.0 - 4.0 kW (MS 4000) 4.0 kg 	96937187	96957524 (1 set = 2 brackets) 1.2 kg H140, b225, B260 for pumps up to 50 kg / 4" up to 7.5 kW
SP46-3 SP46-4-C SP46-4 SP46-5 SP60-3 SP60-4	SP46-2 SP46-3-BB SP46-3 SP46-4-BC SP60-2 SP60-3-A	<ul style="list-style-type: none"> d180 (200) x 1000 Motor 4", 5.5 - 7.5 kW (MS 4000) 4.9 kg 	96937190	

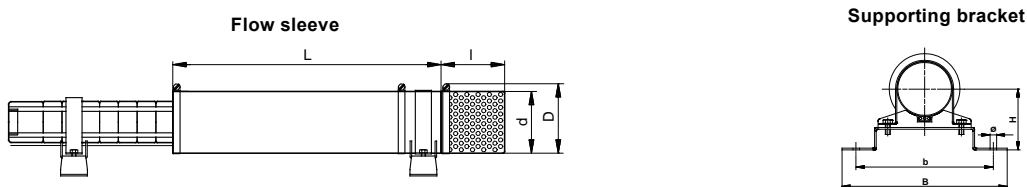

Pump type		Flow sleeve		Strainer	Supporting brackets
50 Hz	60 Hz	Dimensions, d (D) x L Motor type, P2 Weight	Product number	Product number Dimensions d x l Weight	Product number Description
SP46-3 SP46-4-C SP46-4 to -10 SP60-3 to -9B	SP46-2 SP46-3BB SP46-3 SP46-4-BC SP46-4 to 7C SP60-2 SP60-3-A SP60-3 to 6B	<ul style="list-style-type: none"> d200 (220) x 800 Motor 6", up to 15 kW (MS 6000) 5.4 kg 	96937322		96957545
SP46-8 to -15 SP60-7 to -12		<ul style="list-style-type: none"> d200 (220) x 1000 Motor 6", up to 22 kW (MS 6000) 6.4 kg 	96937323	97942247	(1 set = 2 brackets) 2.2 kg H150, b320, B370
SP46-13 to -20 SP60-11 to -17	SP46-7 to -13 SP60-6 to -11	<ul style="list-style-type: none"> d200 (220) x 1250 Motor 6", 18.5 - 30 kW (MS 6000) 6.6 kg 	96937317	d200 x 192 1.0 kg	
SP46-16 to -24 SP60-13 to -21	SP46-14 to -17 SP60-12 to -14	<ul style="list-style-type: none"> d200 (220) x 1700 Motor 6", 26-37 kW (MMS6) 9.3 kg 	96937318		96957549
SP46-21 to -24 SP60-18 to -22	SP60-12 to -17	<ul style="list-style-type: none"> d200 (220) x 1700 Motor 6", 26-37 kW (Franklin 6") 9.3 kg 	96937448		(1 set = 3 brackets) 3.4 kg H150, b320, B370
SP46-21 to -24 SP60-18 to -22	SP46-14 to -17 SP60-12 to -14	<ul style="list-style-type: none"> d254 (270) x 1500 Motor 8", 37-45 kW (MMS 8000) 9.8 kg 	96937463		96957592 (1 set = 3 brackets) 6.0 kg H200, b380, B430
SP60-22	SP46-18 to -19 SP60-15 to -18	<ul style="list-style-type: none"> d254 (270) x 1250 Motor 8", 55 kW (Franklin 8") 8.8 kg 	96937465	97942263	98095530 (1 set = 2 brackets) 6.0 kg H200, b380, B430
SP46-26 to -35 SP60-24 to -30	SP46-20 to -24 SP60-19 to -20	<ul style="list-style-type: none"> d254 (270) x 1500 Motor 8", 45-55 kW (MMS 8000/Franklin 8") Pump in sleeve d154 9.8 kg 	96937472	d256 x 325 1.9 kg	96957561
SP46-37	SP60-21	<ul style="list-style-type: none"> d254 (270) x 1700 Motor 8", 63-75 kW (MMS 8000/Franklin 8") Pump in sleeve d154 9.8 kg 	96937474		(1 set = 3 brackets) 6.3 kg H200, b380, B430

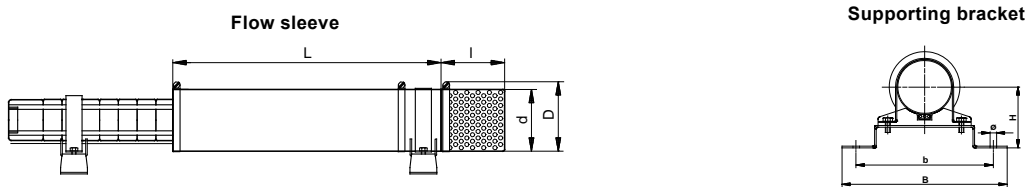

Pump type		Flow sleeve	Strainer	Supporting brackets
50 Hz	60 Hz	Dimensions, d (D) x L Motor type, P2 Weight	Product number Dimensions d x l Weight	Product number Description
SP77-1 to -4 SP95-1 to -4B	SP77-1 SP77-2BA SP77-2-A SP77-2 SP77-3-AA SP77-3-A SP95-1-A SP95-1 SP95-2-AB SP95-2-B SP95-2 SP95-3-BB	<ul style="list-style-type: none"> d210 (225) x 1000 Motor 6", up to 18.5 kW (MS 6000) 5.6 kg 	96937332	96957546 (1 set = 2 brackets) 2.5 kg H160, b330, B380
SP77-5 to -9 SP95-4 SP95-5-AB SP95-5 to -7	SP77-3 to -6-B SP95-3-B SP95-3 SP95-4-AB SP95-4 SP95-5-B	<ul style="list-style-type: none"> d210 (225) x 1250 Motor 6", up to 30 kW (MS 6000) 6.9 kg 	96937440	97942261 d210 x 192 1.1 kg
SP77-7 to -11 SP95-8 to -9	SP77-6 SP77-7 SP95-5 SP95-6	<ul style="list-style-type: none"> d210 (225) x 1700 Motor 6", 26-37 kW (MMS6) 10.6 kg 	96937319	96957553 (1 set = 3 brackets) 6.0 kg H160, b330, B370
SP77-10 to -12 SP95-8 to -10	SP77-6 to -8 SP95-5 to -7	<ul style="list-style-type: none"> d210 (225) x 1700 Motor 6", 37-45 kW (Franklin 6") 9 kg 	96937449	
SP77-10 to -15 SP95-8 to -13	SP77-6 to -10 SP95-5 to -8	<ul style="list-style-type: none"> d254 (270) x 1500 Motor 8", 37-55 kW (MMS 8000/Franklin 8") 12.4 kg 	96937475	
SP77-16 to -21 SP95-14 to -17	SP77-11 to -13 SP95-9 to -11	<ul style="list-style-type: none"> d254 (270) x 1700 Motor 8", 63-75 kW (MMS 8000/Franklin 8") 11 kg 	96937476	97942263 d256 x 325 1.9 kg (1 set = 3 brackets) 5.8 kg H200, b380, B430
SP77-22 SP95-18 to -20	SP77-14 SP77-15 SP95-12 SP95-13	<ul style="list-style-type: none"> d254 (270) x 2000 Motor 8", up to 92 kW (MMS 8000/Franklin 8") 13.4 kg 	96937477	
SP77-19 to -20 SP95-15 to -17	SP95-11	<ul style="list-style-type: none"> d285 (300) x 1500 Motor 10", up to 75 kW (MMS 10000) 11.4 kg 	96937507	97942269 d285 x 385 2.7 kg (1 set = 3 brackets) 10.1 kg H225, b410, B460
SP77-22 SP95-18 to -20	SP95-12 SP95-13	<ul style="list-style-type: none"> d285 (300) x 2000 Motor 10", 92 kW (MMS 10000) 15.1 kg 	96937508	
SP125-1-A SP125-1 SP125-2-AA SP160-1-A SP160-1	SP125-1-A SP125-1 SP160-1-A	<ul style="list-style-type: none"> d254 (270) x 1000 Motor 6", up to 18.5 kW (MS 6000) 6.7 kg 	96937441	96957548 (1 set = 2 brackets) 3.4 kg H200, b380, B430
SP125-2-A SP125-2 SP125-3/A/AA SP160-2/A/AA SP160-3-AA	SP125-2-AA SP125-2-A SP125-2 SP160-1 SP160-2-AA	<ul style="list-style-type: none"> d254 (270) x 1250 Motor 6", up to 30 kW (MS 6000) 8.3 kg 	96937443	97942263 d256 x 325 1.9 kg
SP125-3/3A SP125-4/A/AA SP160-2 SP160-3/A/AA	SP125-3-AA SP125-3-A SP160-2-A SP160-2 SP160-3-AA	<ul style="list-style-type: none"> d254 (270) x 1700 Motor 6", 26-37 kW (MMS6) 11.4 kg 	96937320	96957560 (1 set = 3 brackets) 5.2 kg H200, b380, B430
SP125-4/A/AA SP125-5-A/AA SP160-3-A SP160-4-A/AA	SP125-3-AA SP125-3-A SP125-3 SP160-2-A/-2 SP160-3-AA	<ul style="list-style-type: none"> d254 (270) x 1700 Motor 6", 37-45 kW (Franklin 6") 11.4 kg 	96937450	

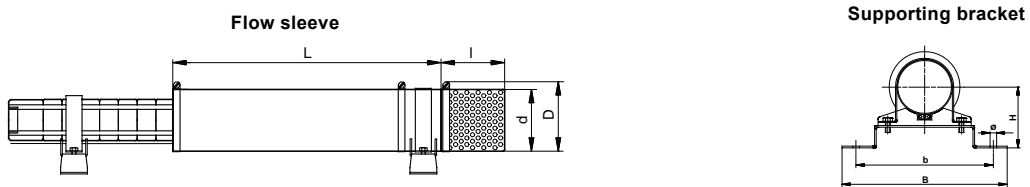

Pump type		Flow sleeve	Strainer	Supporting brackets
50 Hz	60 Hz	Dimensions, d (D) x L Motor type, P2 Weight	Product number Dimensions d x l Weight	Product number Description
SP125-4/A/AA SP125-5/A/AA SP125-6-AA/6-A SP160-3/3-A SP160-4/A/AA SP160-5-AA/5-A	SP125-3-AA SP125-3-A SP125-3 SP125-4-AA SP125-4-A SP160-3-AA SP160-3-A SP160-3	<ul style="list-style-type: none"> d285 (300) x 1500 Motor 8", 37-55 kW (MMS 8000/Franklin 8") 11.4 kg 	96937478	
SP125-6 SP125-7/A/AA SP125-8/A/AA SP160-5 SP160-6/A/AA SP160-7-AA	SP125-4 SP125-5-AA SP125-5-A SP125-5 SP125-6-AA SP160-4-AA SP160-4-A SP160-4	<ul style="list-style-type: none"> d285 (300) x 1700 Motor 8", 63-75 kW (MMS 8000/Franklin 8") 12.8 kg 	96937479	97942269 d285 x 385 2.7 kg 96957595 (1 set = 3 brackets) 10.1 kg H225, b410, B460
SP125-9/A/AA SP125-10/A/AA SP125-11 SP160-7/A SP160-8/A/AA SP160-9/A/AA SP160-10-AA	SP125-6-A/-6 SP125-7-AA SP125-7-A SP125-7 SP160-5-AA SP160-5-A SP160-5 to -6	<ul style="list-style-type: none"> d285 (300) x 2250 Motor 8", up to 92-110 kW (MMS 8000/Franklin 8") 16.8 kg 	96937487	
SP125-7/A/AA SP125-8/A/AA SP125-9/A/AA SP125-10/A/AA SP160-6/6-A SP160-7/A/AA SP160-8/A/AA		<ul style="list-style-type: none"> d330 (350) x 1700 Motor 10", 75-92 kW (MMS 10000) 14.4 kg 	96937510	97942268 d330 x 385 1.9 kg 96957597 (1 set = 3 brackets) 10.5 kg H225, b410, B460
	SP125-8 to -10 SP160-7 to -8	<ul style="list-style-type: none"> d285 (300) x 2600 Motor 8", up to 150 kW (Franklin 8") 19.1 kg 	96937503	97942269 d285 x 385 2.7 kg 96957595 (1 set = 3 brackets) 10.1 kg H225, b410, B460
SP125-12 to -13 SP160-8 to 9/A/AA SP160-10/A SP160-11	96507609 (2502.0261.260)	<ul style="list-style-type: none"> d330 (350) x 2000 Motor 10", up to 132 kW (MMS 10000) 17.2 kg 	96937522	97942268 96957597 (1 set = 3 brackets) 10.5 kg H225, b450, B460
SP125-14 to -17 SP160-12 to -14	SP125-10 to -11 SP160-8 to -9	<ul style="list-style-type: none"> d330 (350) x 2500 Motor 10", up to 147-170 kW (MMS 10000) 21.2 kg 	96937524	d330 x 385 1.9 kg
	SP125-11 to -13 SP160-9 to -10	<ul style="list-style-type: none"> d380 (400) x 2000 Motor 12", up to 190 kW (MMS 12000) 19.6 kg 	96937555	97942272 96957599 (1 set = 3 brackets) 12.1 kg H270, b550, B600
SP160-15		<ul style="list-style-type: none"> d380 (400) x 2250 Motor 12", 190 kW (MMS 12000) 21.9 kg 	96937529	d380 x 385 4.1 kg

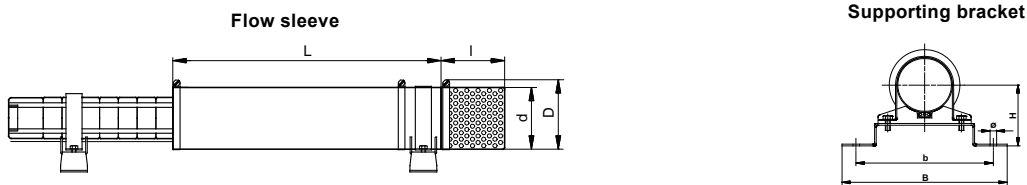

Pump type		Flow sleeve	Strainer	Supporting brackets
50 Hz	60 Hz	Dimensions, d (D) x L Motor type, P2 Weight	Product number Dimensions d x l Weight	Product number Description
SP215-1-A SP215-1 SP215-2-AA	SP215-1-A SP215-1	<ul style="list-style-type: none"> d330 (350) x 1250 Motor 6", up to 30 kW (MS 6000) 10.6 kg 		96958364 (1 set = 2 brackets) 10.0 kg H250, b500, B550
SP215-2-AA SP215-2A	SP215-1	<ul style="list-style-type: none"> d330 (350) x 1800 Motor 6", 30-37 kW (MMS6) 16.5 kg 		
SP215-2-A SP215-2	SP215-2-AA	<ul style="list-style-type: none"> d330 (350) x 1800 Motor 6", 37-45 kW (Franklin 6") 16.5 kg 		
SP215-2-A SP215-2 SP215-3-AA SP215-3-A SP215-3 SP215-4-AA SP215-4-A SP215-4	SP215-2 SP215-2A SP215-2AA SP215-3-AA	<ul style="list-style-type: none"> d330 (350) x 1800 Motor 8", up to 75 kW (MMS 8000/Franklin 8") 14.6 kg 		
SP215-5-AA SP215-5-A SP215-5 SP215-6-AA SP215-6-A	SP215-3-A SP215-3 SP215-4-AA SP215-4-A SP215-4	<ul style="list-style-type: none"> d330 (350) x 2250 Motor 8", up to 110 kW (MMS 8000/Franklin 8") 19.1 kg 	97942268	
SP215-7-AA SP215-7-A SP215-7	SP215-5-AA SP215-5-A	<ul style="list-style-type: none"> d330 (350) x 2500 Motor 8", 130 kW (Franklin 8") 21.1 kg 	d330 x 385 1.9 kg	96957555 (1 set = 3 brackets) 10.7 kg H250, b500, B550
SP215-8-AA SP215-8-A SP215-8	SP215-5	<ul style="list-style-type: none"> d330 (350) x 2700 Motor 8", 150 kW (Franklin 8") 22.8 kg 		
SP215-4-AA SP215-4-A SP215-4 SP215-5-AA SP215-5-A SP215-5		<ul style="list-style-type: none"> d330 (350) x 1800 Motor 10", up to 92 kW (MMS 10000) 16.5 kg 		
SP215-6-AA SP215-6-A SP215-6 SP215-7-AA SP215-7-A SP215-7	SP215-5-AA SP215-5-A	<ul style="list-style-type: none"> d330 (350) x 2250 Motor 10", up to 132 kW (MMS 10000) 19.1 kg 		
SP215-8-AA SP215-8-A SP215-8 SP215-9-AA SP215-9-A SP215-9	SP215-5 SP215-6-AA SP215-6-A	<ul style="list-style-type: none"> d330 (350) x 2500 Motor 10", up to 170 kW (MMS 10000) 21.2 kg 		
SP215-7-AA SP215-7-A SP215-7 SP215-8-AA SP215-8-A SP215-8 SP215-9-AA SP215-9-A SP215-9 SP215-10-AA SP215-10-A SP215-10	SP215-6-AA SP215-6-A SP215-6 SP215-7-AA SP215-7-A SP215-7	<ul style="list-style-type: none"> d380 (400) x 2250 Motor 12", up to 190 kW (MMS 12000) 21.9 kg 	97942272	96957600 (1 set = 3 brackets) 12 kg H270, b550, B600
SP215-11		<ul style="list-style-type: none"> d380 (400) x 2500 Motor 12", 220 kW (MMS 12000) 24.2 kg 		

6. Flow sleeve SP-G EN 1.4301/AISI 304

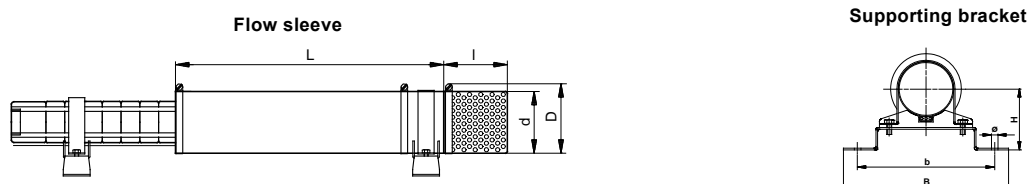

Pump type		Flow sleeve	Strainer	Supporting brackets
50 Hz	60 Hz	Dimensions, d (D) x L Motor type, P2 Weight	Product number Dimensions d x l Weight	Product number Description
SP270-1L G		<ul style="list-style-type: none"> d380 (400) x 1250 Motor 8", 22 kW (MMS 8000) 19.8 kg 		97513263 (1 set = 2 brackets) 9.0 kg H270, b500, B550
SP270-1F G to -1D G SP300-1N G to -1L G		<ul style="list-style-type: none"> d380 (400) x 1400 Motor 8", 26-30 kW (MMS 8000) 27.1 kg 	97535185	
SP270-1A G to -2L G SP300-1D G to -1A G	SP270-1G G to -1A G	<ul style="list-style-type: none"> d380 (400) x 1500 Motor 8", 37-45 kW (MMS 8000) 28.1 kg 	97535197	
SP270-2D G to -2A G SP300-2L G to -2F G	SP270-2N G	<ul style="list-style-type: none"> d380 (400) x 1800 Motor 8", 55-63 kW (MMS 8000) 30.8 kg 	97535198	
SP270-V G SP300-2D G to -3L G	SP270-2G G	<ul style="list-style-type: none"> d380 (400) x 2000 Motor 8", 75 kW (MMS 8000) 32.5 kg 	97535200	97942272
SP270-3A G SP300-3F G	SP270-2A G	<ul style="list-style-type: none"> d380 (400) x 2250 Motor 8", 92 kW (MMS 8000) 34.9 kg 	97535212	d380 x 385 4.1 kg 97512818 (1 set = 3 brackets) 13.3 kg H270, b500, B550
SP270-4D G SP300-3D G		<ul style="list-style-type: none"> d380 (400) x 2500 Motor 8", 110 kW (MMS 8000) 38.9 kg 	97535438	
SP270-4D G SP300-3D G	SP270-3L G	<ul style="list-style-type: none"> d380 (400) x 2000 Motor 10", 110 kW (MMS 10000) 34.5 kg 	97535442	
SP270-4A G to -6W G SP300-3A G to -4F G	SP270-3F G to -3D G	<ul style="list-style-type: none"> d380 (400) x 2250 Motor 10", 132 kW (MMS 10000) 36.7 kg 	97535444	
SP270-6F G SP300-4D G to -5G G	SP270-3A G to -4F G	<ul style="list-style-type: none"> d380 (400) x 2500 Motor 10", 147 kW (MMS 10000) 39.1 kg 	97535445	

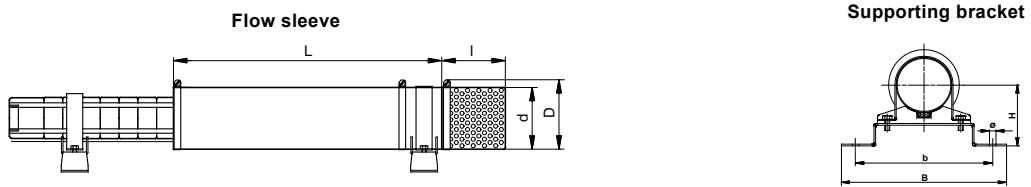

Pump type		Flow sleeve	Strainer	Supporting brackets
50 Hz	60 Hz	Dimensions, d (D) x L Motor type, P2 Weight	Product number	Product number Dimensions d x l Weight
		Product number	Product number Dimensions d x l Weight	Product number Description
SP270-6D G to -6A G SP300-5F G to -6F G		<ul style="list-style-type: none"> d420 (450) x 2250 Motor 12", 170-190 kW (MMS 12000) 34.7 kg 	97714558	
SP270-7A G to -8A G SP300-6D G to -7D G		<ul style="list-style-type: none"> d420 (450) x 2500 Motor 12", 220-250 kW (MMS 12000) 37.4 kg 	97549359	
SP360-1L G to -1F G		<ul style="list-style-type: none"> d420 (450) x 1500 Motor 8", 37-45 kW (MMS 8000) 32.5 kg 	97714571	
SP360-1A G to -2N G		<ul style="list-style-type: none"> d420 (450) x 1750 Motor 8", 55-63 kW (MMS 8000) 36.5 kg 	97714573	
SP360-2L G		<ul style="list-style-type: none"> d420 (450) x 2000 Motor 8", 75 kW (MMS 8000) 37.7 kg 	97535440	97942443 97512833
SP360-2F G		<ul style="list-style-type: none"> d420 (450) x 2250 Motor 8", 92 kW (MMS 8000) 38.9 kg 	97535441	d420 x 385 4.5 kg (1 set = 3 brackets) 12.5 kg H300, b575, B625
SP360-2A G to -3L G		<ul style="list-style-type: none"> d420 (450) x 2500 Motor 8", 110 kW (MMS 8000) 41.5 kg 	97549345	
SP360-2A G to -3L G		<ul style="list-style-type: none"> d420 (450) x 2000 Motor 10", 110 kW (MMS 10000) 36.2 kg 	97535446	
SP360-3G G to -3F G		<ul style="list-style-type: none"> d420 (450) x 2250 Motor 10", 132 kW (MMS 10000) 38.7 kg 	97549349	
SP360-3D G		<ul style="list-style-type: none"> d420 (450) x 2500 Motor 10", 147 kW (MMS 10000) 41.3 kg 	97549355	
SP360-3A G to -5G G		<ul style="list-style-type: none"> d420 (480) x 2250 Motor 12", 170-190 kW (MMS 12000) 40.8 kg 	97535447	97942462 97513065
SP360-5F G to -6F G		<ul style="list-style-type: none"> d420 (480) x 2500 Motor 12", 220-250 kW (MMS 12000) 42.8 kg 	97535448	d420 x 385 5.3 kg (1 set = 3 brackets) 14.3 kg H315, b500, B550

7. Flow sleeve, R-version, EN 1.4539/AISI 904L

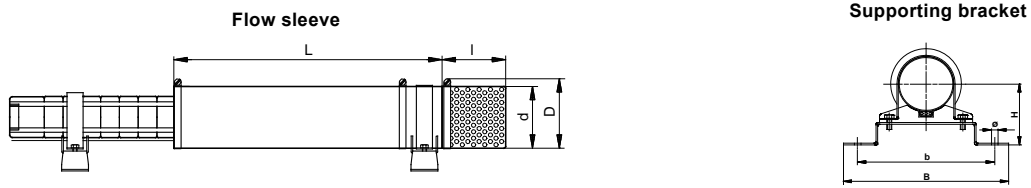

Pump type		Flow sleeve	Strainer	Supporting brackets
50 Hz	60 Hz	Description: Dimensions, d (D) x L Motor type, P2 Weight	Product number: Grundfos	Product number: Grundfos Description
SP5A-4 to -8	SP5A-3 to -7	<ul style="list-style-type: none"> d115 (130) x 400 Motor 4", up to 0.75 kW (MS 4000) 1.5 kg 	96898594	
SP3A -6 to -33 SP5A -4 to -33 SP5A-12 to -17 SP7 - 1 to -12 SP9- 1to - 11 SP11-1 to -11 SP14-1 to -6	SP3A-5 to 24 SP5A-3 to 26 SP5A-9 to -11 SP 7 - 1 to -8 SP9 -4 to -7 SP11-3 to -7 SP14-1 to -4	<ul style="list-style-type: none"> d115 (130) x 550 Motor 4", up to 2.2 kW (MS 4000) 1.7 kg 	96937598	96958367 (1 set = 2 brackets) 0.7 kg H100, b185, B220 for pumps up to 50 kg / 4" up to 5.5 kW
SP3A-6 to 33 SP5A-4 to -60 SP7 - 13 to 42 SP9-8 to -32 SP11-11 to -27 SP14-7 to -23	SP5A-15 to -39 SP7 - 8 to 28 SP9-7 to -19 SP11 -3 to -18 SP14-5 to -15	<ul style="list-style-type: none"> d115 (130) x 800 Motor 4", up to 5.5 kW (MS 4000) 2.5 kg 	96937633	d115 x 117 0.4 kg 96958371
SP7 - 42 to 59 SP9-32 to -40 SP11-28 to -37 SP14-24 to -31	SP7 - 29 to 38 SP9-19 to -25 SP11-19 to -24 SP14-16 to -20	<ul style="list-style-type: none"> d115 (130) x 1000 Motor 4", 7.5 kW (MS 4000) 3.1 kg 	96898643	(1 set = 2 brackets) 0.9 kg H100, b235, B275
SP5A-52 to -60 SP7 -32 to -59 SP9-23 to -40 SP11-21 to -37 SP14-18 to -31	SP5A-39 SP7 - 21 to -38 SP9-17 to -25 SP11-19 to -24 SP14-12 to -20	<ul style="list-style-type: none"> d160 (180) x 800 Motor 6", up to 7.5 kW (MS 6000) 4.9 kg 	96937224	98557134 (1 set = 2 brackets) 1.4 kg H115, b185, B220
SP9 -41 to -55	SP9 -26 to -38	<ul style="list-style-type: none"> d160 (180) x 1000 Motor 6", up to 11 kW (MS 6000) 4.0 kg 	98779731	97941790 d160 x 158 0.8 kg
SP2A-75 to -90	SP2A-58 SP3A-56	<ul style="list-style-type: none"> d160 (180) x 1000 Motor 4", up to 7.5 kW (MS 4000) Pump in sleeve d108 4.3 kg 	96898645	96958373 (1 set = 2 brackets) 1.4 kg H125, b185, B220
SP5A-75 to -85 SP7 - 60 to 100 SP9 -56 to -93	SP3A-56 to -75 SP5A-52 SP7 - 41 to 67 SP9-39 to -63	<ul style="list-style-type: none"> d180 (200) x 1000 Motor 6", up to 18.5 kW (MS 6000) Pump in sleeve d108 4.9 kg 	96937690	97941786 d180 x 192 0.8 kg 96958375 (1 set = 2 brackets) 2.0 kg H140, b300, B350
SP17-1 to 4 SP30-1 to 2		<ul style="list-style-type: none"> d145 (160) x 625 Motor 4", up to 2.2 kW (MS 4000) 3.7 kg 	96898600	
SP17-2 SP17-3 (3~) SP30-1 to -2	SP17-1 to -2 SP30-1	<ul style="list-style-type: none"> d145 (160) x 550 Motor 4", up to 2.2 kW (MS 4000) 2.2 kg 	96898601	97941782 d145 x 158 0.6 kg 96958368 (1 set = 2 brackets) 0.8 kg
SP17-3 (1~) SP17-4 to -7 SP30-3 to -4	SP17-3 to -6 SP30-2 to -3	<ul style="list-style-type: none"> d145 (160) x 800 Motor 4", up to 4 kW (MS 4000) 3.1 kg 	96898638	for pumps up to 50 kg / 4" up to 7.5 kW H115, b185, B220
SP17-8 to -13 SP30-5 to -8	SP17-7 to -9 SP30-4 to -5	<ul style="list-style-type: none"> d145 (160) x 1000 Motor 4", 5.5 - 7.5 kW (MS 4000) 3.8 kg 	96898640	

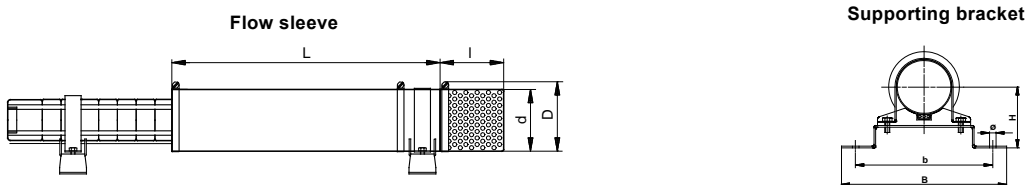

Pump type		Flow sleeve	Strainer	Supporting brackets
50 Hz	60 Hz	Description: Dimensions, d (D) x L Motor type, P2 Weight	Product number: Grundfos Dimensions d x l Weight	Product number: Grundfos Description
SP17-8 to -24 SP30-5 to -15	SP17-5 to -15 SP30-4 to -10	<ul style="list-style-type: none"> d180 (200) x 800 Motor 6", 6 to 13 kW (MS 6000) 5.6 kg 	96937689	
SP17-25 to -40 SP30-16 to -26	SP17-16 to -26 SP30-11 to -17	<ul style="list-style-type: none"> d180 (200) x 1000 Motor 6", up to 22 kW (MS 6000) 5.4 kg 	96937691	96958375 (1 set = 2 brackets) 2.0 kg H140, b300, B350
SP30-27 to -35	SP17-27 to -30 SP30-18 to -23	<ul style="list-style-type: none"> d180 (200) x 1250 Motor 6", 26 to 30 kW (MS 6000) 4.9 kg 	96937723	d180 x 192 0.9 kg
SP30-27 to -35	SP30-24 to -28	<ul style="list-style-type: none"> d180 (200) x 1700 Motor 6", up to 26-30 kW (MMS6) 8.5 kg 	96898633	96958376 (1 set = 3 brackets) 2.3 kg H140, b310, B350
SP17-43 to -53	SP17-33 to -36	<ul style="list-style-type: none"> d200 (220) x 1250 Motor 6", 26-30 kW (MS 6000) Pump in sleeve d154 6.0 kg 	96937722	96960265 (1 set = 2 brackets) 2.3 kg H150, b320, B370
SP17-43 to -60 SP30-39 to -43	SP17-39 to -42	<ul style="list-style-type: none"> d200 (220) x 1700 Motor 6", 26-37 kW (MMS6) Pump in sleeve d154 9.3 kg 	96898634	97941767 d200 x 192 1.0 kg 97757234
SP17-55 to -60 SP30-39 to -49	SP17-45 to -50	<ul style="list-style-type: none"> d200 (220) x 1700 Motor 6", 37-45 kW (Franklin 6") Pump in sleeve d154 10.8 kg 	96898650	(1 set = 3 brackets) 3.3 kg H150, b340, B370
SP30-46 to -54	SP17-42 to -50 SP30-29 to -39	<ul style="list-style-type: none"> d254 (270) x 1500 Motor 8", 45-55 kW (MMS 8000/Franklin 8") Pump in sleeve d154 9.8 kg 	96900228	96958411 (1 set = 3 brackets) 4.7 kg H200, b380, B430
SP46-1-B SP46-1 SP46-2-BB SP60-1-A SP60-1	SP46-1-B SP46-1-B SP46-1-A SP60-1-B	<ul style="list-style-type: none"> d180 (200) x 625 Motor 4", up to 2.2 kW (MS 4000) 2.9 kg 	96898632	
SP46-2 SP46-3-C SP60-2-B SP60-2	SP46-1 SP46-2-AB SP60-1-A SP60-1 SP60-2-BB	<ul style="list-style-type: none"> d180 (200) x 800 Motor 4" 3.0 - 4.0 kW (MS 4000) 6.9 kg 	96898641	96958370 (1 set = 2 brackets) 1.2 kg H140, b225, B260 for pumps up to 50 kg / 4" up to 7.5 kW
SP46-3 SP46-4-C SP46-4 SP46-5 SP60-3 SP60-4	SP46-2 SP46-3-BB SP46-3 SP46-4-BC SP60-2 SP60-3-A	<ul style="list-style-type: none"> d180 (200) x 1000 Motor 4", 5.5 - 7.5 kW (MS 4000) 4.9 kg 	96898642	

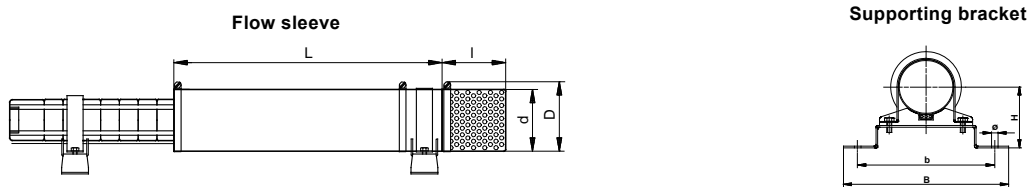

Pump type		Flow sleeve	Strainer	Supporting brackets
50 Hz	60 Hz	Description: Dimensions, d (D) x L Motor type, P2 Weight	Product number: Grundfos Dimensions d x l Weight	Product number: Grundfos Description
SP46-3 SP46-4-C SP46-4 to -12 SP60-3 to -10	SP46-3 SP46-4-BC SP46-4 to -8 SP60-3-A SP60-3 to -7	<ul style="list-style-type: none"> d200 (220) x 1000 Motor 6", up to 22 kW (MS 6000) 5.4 kg 	96937744	96958381 (1 set = 2 brackets) 2.2 kg H150, b320, B370
SP46-13 to -20 SP60-11 to -17	SP46-9 to -13 SP60-8 to -11	<ul style="list-style-type: none"> d200 (220) x 1250 Motor 6", 22-30 kW (MS 6000) 6.6 kg 	96898635	97941767
SP46-16 to -24 SP60-13 to -21	SP46-14 to -17 SP60-12 to -14	<ul style="list-style-type: none"> d200 (220) x 1700 Motor 6", 26-37 kW (MMS6) 9.3 kg 	96898636	d200 x 192 1.0 kg
SP46-21 to -24 SP60-18 to -22	SP60-12 to -17	<ul style="list-style-type: none"> d200 (220) x 1700 Motor 6", 26-37 kW (Franklin 6") 9.3 kg 	96898651	96958389 (1 set = 3 brackets) 3.4 kg H150, b380, B370
SP46-21 to -24 SP60-18 to -22	SP46-14 to -17 SP60-12 to -14	<ul style="list-style-type: none"> d254 (270) x 1500 Motor 8", 37-45 kW (MMS 8000) 9.8 kg 	96900357	96958412 (1 set = 3 brackets) 6.0 kg H200, b320, B430
SP60-22	SP46-18 to -19 SP60-15 to -18	<ul style="list-style-type: none"> d256 (270) x 1250 Motor 8", 45 kW (Franklin 8") 10.9 kg 	96900358	98095556 (1 set = 2 brackets) 4.5 kg H200, b380, B430
SP46-26 to -35 SP60-24 to -30	SP46-20 to -24 SP60-19 to -20	<ul style="list-style-type: none"> d254 (270) x 1500 Motor 8", 45-55 kW (MMS 8000/Franklin 8") Pump in sleeve d154 9.8 kg 	96900360	d256 x 325 1.9 kg
SP46-37	SP60-21	<ul style="list-style-type: none"> d254 (270) x 1700 Motor 8", 63-75 kW (MMS 8000/Franklin 8") Pump in sleeve d154 12.4 kg 	96900361	96958411 (1 set = 3 brackets) 6.3 kg H200, b380, B430
SP77-1 to -4 SP95-1 to -4B	SP77-1 SP77-2BA SP77-2-A SP77-2 SP77-3-AA SP77-3-A SP95-1-A SP95-1 SP95-2-AB SP95-2-B SP95-2 SP95-3-BB	<ul style="list-style-type: none"> d210 (225) x 900 (1000) Motor 6", up to 15 kW (MS 6000) 5.6 kg 	96937749	96958385 (1 set = 2 brackets) 2.5 kg H160, b330, B380
SP77-5 to -9 SP95-4 SP95-5-AB SP95-5 to -7	SP77-3 to -6-B SP95-3-B SP95-3 SP95-4-AB SP95-4 SP95-5-B	<ul style="list-style-type: none"> d210 (225) x 1250 Motor 6", up to 30 kW (MS 6000) 6.9 kg 	96937750	97941757
SP77-7 to -11 SP95-8 to -9	SP77-6 SP77-7 SP95-5 SP95-6	<ul style="list-style-type: none"> d210 (225) x 1700 Motor 6", 26-37 kW (MMS6) 10.6 kg 	96898646	96958405
SP77-10 to -12 SP95-8 to -10	SP77-6 to -8 SP95-5 to -7	<ul style="list-style-type: none"> d210 (225) x 1700 Motor 6", 37 kW (Franklin 6" Rw = Rewindable) 9 kg 	96898712	(1 set = 3 brackets) 6.0 kg H160, b330, B380

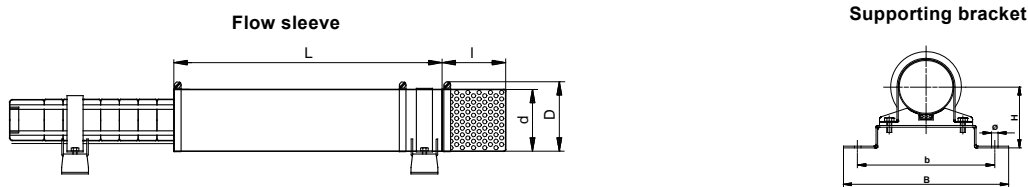

Pump type		Flow sleeve	Strainer	Supporting brackets
50 Hz	60 Hz	Description: Dimensions, d (D) x L Motor type, P2 Weight	Product number: Grundfos Dimensions d x l Weight	Product number: Grundfos Description
SP77-10 to -15 SP95-8 to -13	SP77-6 to -10 SP95-5 to -8	<ul style="list-style-type: none"> d254 (270) x 1500 Motor 8", 37-55 kW (MMS 8000/Franklin 8") 9.8 kg 	96900372	
SP77-16 to -21 SP95-14 to -17	SP77-11 to -13 SP95-9 to -11	<ul style="list-style-type: none"> d254 (270) x 1700 Motor 8", 63-75 kW (MMS 8000/Franklin 8") 11 kg 	96900373	97941815 d256 x 325 1.9 kg 96958414 (1 set = 3 brackets) 6.0 kg H200, b380, B430
SP77-22 SP95-18 to -20	SP77-14 SP77-15 SP95-12 SP95-13	<ul style="list-style-type: none"> d254 (270) x 2000 Motor 8", up to 92 kW (MMS 8000/Franklin 8") 13.4 kg 	96900374	
SP77-19 to -20 SP95-15 to -17	SP95-11	<ul style="list-style-type: none"> d285 (300) x 1500 Motor 10", up to 75 kW (MMS 10000) 11.4 kg 	96900398	97941547 97695339
SP77-22 SP95-18 to -20	SP95-12 SP95-13	<ul style="list-style-type: none"> d285 (300) x 2000 Motor 10", 92 kW (MMS 10000) 15.1 kg 	96900400	d285 x 385 2.7 kg (1 set = 3 brackets) 10.1 kg H225, b410, B460
SP125-1-A R SP160-1-A R	SP125-1-A R SP160-1-A R	<ul style="list-style-type: none"> d254 (270) x 1000 Motor 6", up to 13 kW (MS 6000) 6.7 kg 	96937751	96958386
SP125-2-A SP125-2 SP125-3/A/AA SP160-2/A/AA SP160-3-AA	SP125-2-AA SP125-2-A SP125-2 SP160-1 SP160-2-AA	<ul style="list-style-type: none"> d254 (270) x 1250 Motor 6", up to 30 kW (MS 6000) 8.3 kg 	96937754	(1 set = 2 brackets) 3.4 kg H200, b380, B430
SP125-3/3A SP125-4/A/AA SP160-2 SP160-3/A/AA	SP125-3-AA SP125-3-A SP160-2-A SP160-2 SP160-3-AA	<ul style="list-style-type: none"> d254 (270) x 1700 Motor 6", 26-37 kW (MMS6) 11.4 kg 	96898647	97941815 d256 x 325 1.9 kg 96958410
SP125-4/A/AA SP160-3-A	SP125-3-AA SP125-3-A SP160-2-A/ -2	<ul style="list-style-type: none"> d254 (270) x 1700 Motor 6", 37 kW (Franklin 6" Rw*) 11.4 kg (* Rw = Rewindable) 	96900223	(1 set = 3 brackets) 5.2 kg H200, b380, B430
SP125-4/A/AA SP125-5/A/AA SP125-6-AA/6-A SP160-3/3-A SP160-4/A/AA SP160-5-AA/5-A	SP125-3-AA SP125-3-A SP125-3 SP125-4-AA SP125-4-A SP160-3-AA SP160-3-A SP160-3	<ul style="list-style-type: none"> d285 (300) x 1500 Motor 8", 37-55 kW (MMS 8000/Franklin 8") 11.4 kg 	96937759	
SP125-6 SP125-7/A/AA SP125-8/A/AA SP160-5 SP160-6/A/AA SP160-7-AA	SP125-4 to 125-6AA SP160-4-AA SP160-4-A SP160-4	<ul style="list-style-type: none"> d285 (300) x 1700 Motor 8", 63-75 kW (MMS 8000/Franklin 8") 12.8 kg 	96900376	97941547 d285 x 385 2.7 kg 96958416 (1 set = 3 brackets) 10.1 kg H225, b410, B460
SP125-9/A/AA SP125-10/A/AA SP125-11 SP160-7/A SP160-8/A/AA SP160-9/A/AA SP160-10-AA	SP125-6-A/-6 SP125-7-AA SP125-7-A SP125-7 SP160-5-AA SP160-5-A SP160-5 to -6	<ul style="list-style-type: none"> d285 (300) x 2250 Motor 8", up to 92-110 kW (MMS 8000/Franklin 8") 16.8 kg 	96900379	
SP125-7/A/AA SP125-8/A/AA SP125-9/A/AA SP125-10/A/AA SP160-6/6-A SP160-7/A/AA SP160-8/A/AA		<ul style="list-style-type: none"> d330 (350) x 1700 Motor 10", 75-92 kW (MMS 10000) 14.4 kg 	96900401	97941751 d330 x 385 1.9 kg 96958418 (1 set = 3 brackets) 10.5 kg H225, b450, B500

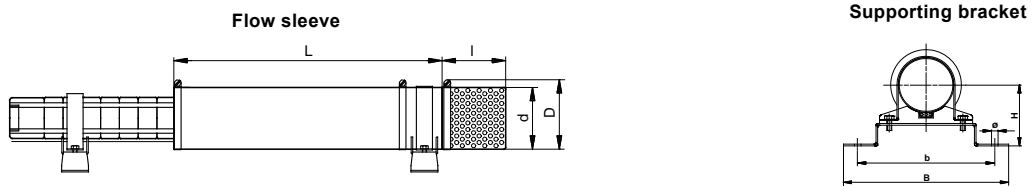

Pump type		Flow sleeve		Strainer	Supporting brackets
50 Hz	60 Hz	Description: Dimensions, d (D) x L Motor type, P2 Weight	Product number: Grundfos	Product number: Grundfos Dimensions d x l Weight	Product number: Grundfos Description
	SP125-8 to -10 SP160-7 to -8	<ul style="list-style-type: none"> d285 (300) x 2600 Motor 8", up to 150 kW (Franklin 8") 19.1 kg 	96900394	97941547 d285 x 385 1.9 kg	96958416 (1 set = 3 brackets) 10.1 kg H225, b410, B460
SP125-12 to -13 SP160-9/A/AA SP160-10/A SP160-11		<ul style="list-style-type: none"> d330 (350) x 2000 Motor 10", up to 132 kW (MMS 10000) 17.2 kg 	96900432	97941751	96958418
SP125-14 to -17 SP160-12 to -14	SP125-10 to -11 SP160-8 to -9	<ul style="list-style-type: none"> d330 (350) x 2500 Motor 10", up to 147-170 kW (MMS 10000) 21.2 kg 	96900434	d330 x 385 1.9 kg	(1 set = 3 brackets) 10.5 kg H225, b450, B500
	SP125-11 to -13 SP160-9 to -10	<ul style="list-style-type: none"> d380 (400) x 2000 Motor 12", up to 190 kW (MMS 12000) 19.6 kg 	96900455	97941817	96958419
SP160-15		<ul style="list-style-type: none"> d380 (400) x 2250 Motor 12", 190 kW (MMS 12000) 21.9 kg 	96900439	d380 x 385 4.1 kg	(1 set = 3 brackets) 12.1 kg H270, b550, B600

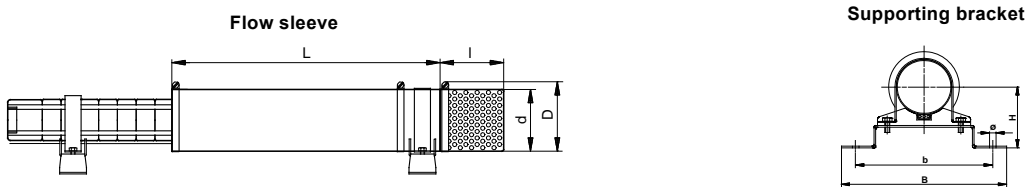

Pump type		Flow sleeve	Strainer	Supporting brackets
50 Hz	60 Hz	Description: Dimensions, d (D) x L Motor type, P2 Weight	Product number: Grundfos Dimensions d x l Weight	Product number: Grundfos Description
SP215-1- A R		<ul style="list-style-type: none"> d330 (350) x 1000 Motor 6", up to 15 kW (MS 6000) 12 kg 	96937756	97695341
SP215-1-A SP215-1 SP215-2-AA	SP215-1-A SP215-1	<ul style="list-style-type: none"> d330 (350) x 1250 Motor 6", up to 30 kW (MS 6000) 15 kg 	96937757	(1 set = 2 brackets) 10.0 kg H250, b500, B550
SP215-2-AA SP215-2A	SP215-1	<ul style="list-style-type: none"> d330 (350) x 1800 Motor 6", 30-37 kW (MMS6) 16.5 kg 	96898649	
SP215-2-A SP215-2	SP215-2-AA	<ul style="list-style-type: none"> d330 (350) x 1800 Motor 6", 37-45 kW (Franklin 6") 16.5 kg 	96900226	
SP215-2-A R		<ul style="list-style-type: none"> d330 (350) x 1500 Motor 8", up to 35 kW (MMS 8000/Franklin 8") 14.1 kg 	96937758	
SP215-2-A SP215-2 SP215-3-AA SP215-3-A SP215-3 SP215-4-AA SP215-4-A SP215-4	SP215-2 SP215-3-AA	<ul style="list-style-type: none"> d330 (350) x 1800 Motor 8", up to 75 kW (MMS 8000/Franklin 8") 14.6 kg 	96900377	
SP215-5-AA SP215-5-A SP215-5 SP215-6-AA SP215-6-A	SP215-3-A SP215-3 SP215-4-AA SP215-4-A SP215-4	<ul style="list-style-type: none"> d330 (350) x 2250 Motor 8", up to 110 kW (MMS 8000/Franklin 8") 19.1 kg 	96900381	97941751 d330 x 385 1.9 kg 97757301
SP215-7-AA SP215-7-A SP215-7	SP215-5-AA SP215-5-A	<ul style="list-style-type: none"> d330 (350) x 2500 Motor 8", 130 kW (Franklin 8") 21.2 kg 	96900392	(1 set = 3 brackets) 10.7 kg H250, b500, B550
SP215-8-AA SP215-8-A SP215-8	SP215-5	<ul style="list-style-type: none"> d330 (350) x 2700 Motor 8", 150 kW (Franklin 8") 22.8 kg 	96900393	
SP215-4-AA SP215-4-A SP215-4 SP215-5-AA SP215-5-A SP215-5		<ul style="list-style-type: none"> d330 (350) x 1800 Motor 10", up to 92 kW (MMS 10000) 16.5 kg 	96900435	
SP215-6-AA SP215-6-A SP215-6 SP215-7-AA SP215-7-A SP215-7	SP215-5-AA SP215-5-A	<ul style="list-style-type: none"> d330 (350) x 2250 Motor 10", up to 132 kW (MMS 10000) 19.1 kg 	96900436	
SP215-8-AA SP215-8-A SP215-8 SP215-9-AA SP215-9-A SP215-9	SP215-5 SP215-6-AA SP215-6-A SP215-6	<ul style="list-style-type: none"> d330 (350) x 2500 Motor 10", up to 170 kW (MMS 10000) 21.2 kg 	96900437	

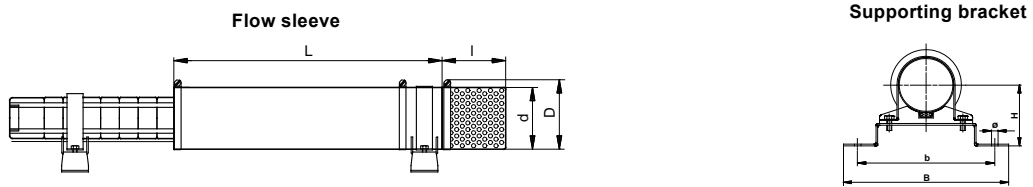

Pump type		Flow sleeve	Strainer	Supporting brackets
50 Hz	60 Hz	Description: Dimensions, d (D) x L Motor type, P2 Weight	Product number: Grundfos Dimensions d x l Weight	Product number: Grundfos Description
SP215-7-AA SP215-7-A SP215-7				
SP215-8-AA SP215-8-A SP215-8	SP215-6-AA SP215-6-A	<ul style="list-style-type: none"> d380 (400) x 2250 Motor 12", up to 190 kW (MMS 12000) 	96900440	96958420
SP215-9-AA SP215-9-A SP215-9	SP215-7-AA SP215-7-A	<ul style="list-style-type: none"> 21.9 kg 		(1 set = 3 brackets) 12 kg
SP215-10-AA SP215-10-A SP215-10	SP215-7		d380 x 385 4.0 kg	H270, b550, B600
SP215-11		<ul style="list-style-type: none"> d380 (400) x 2500 Motor 12", 220 kW (MMS 12000) 24.2 kg 	96900441	

Flow sleeves, strainers and supporting brackets are not available for SPG of EN 1.4539/AISI 904L.

8. Zinc anodes

Galvanic cathodic protection

Applications

Galvanic cathodic protection enables protection of SQF, SP A, SP and SPG pumps as well as submersible motors against corrosion caused by chloride-containing liquids, such as seawater and brackish water.

Pumps in sleeves cannot be protected using zinc anodes.

Applicable on these versions:

Pump/motor	Version
Pump	N or R version
Motor, Grundfos	R version
Motor, other makes	Seawater-resistant materials, for example bronze, N or R version

Pumped liquids

Water containing more than 1500 ppm chloride at temperatures up to 35 °C.

We do not recommend galvanic cathodic protection in liquids with a pH value lower than 6.

Construction

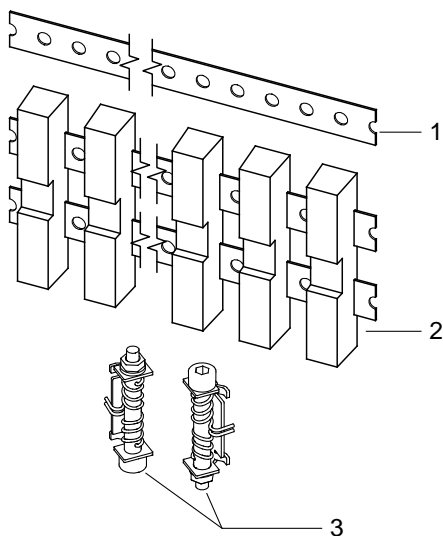

TM01 4430 0199

Fig. 1 Anode string

Pos.	Description
1	Stainless-steel clamp
2	Zinc anodes cast around the clamp
3	Spring device ensuring direct metallic contact with pump/motor

During operation, the size of the zinc anodes will be reduced and gradually the anodes become covered by corrosion products obstructing the direct metallic contact between anode and pump/motor. To counteract this, the metallic contact must be ensured via the clamp keeping tight contact with pump/motor by means of the spring device.

Fitting the anode strings

The anode strings are to be fitted according to the installation and operating instructions.

The number of anode strings to be fitted is shown in [Anode strings on pumps](#) on page 38 and [Position of anode strings on motors](#).

Important: Ensure that the anode strings are fastened tightly and that the electric/metallic contact between clamp and pump/motor is good.

The diameter of the pump/motor is increased by minimum 40 mm when the anode string is fitted.

Position of anode strings on pumps

One anode string

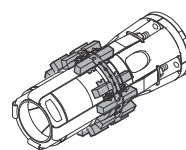

TM05 0533 1211

Fig. 2 One anode string

Two anode strings

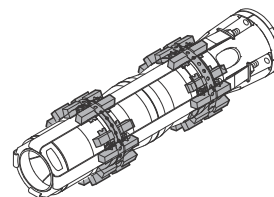

TM05 0534 1211

Fig. 3 Two anode strings

More than two anode strings

The distances between the anode strings must be identical.

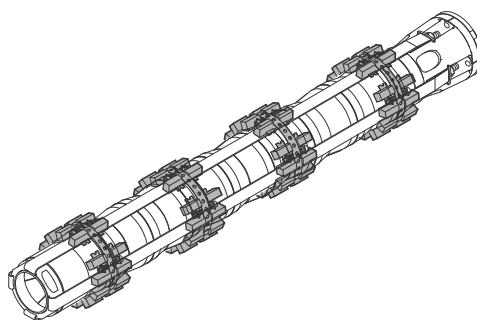

TM05 0535 1211

Fig. 4 More than two anode strings

Position of anode strings on motors

Two anode strings

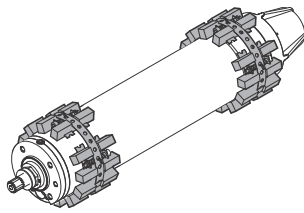

TIM05 0536 1211

Fig. 5 Two anode strings

More than two anode strings

The distances between the anode strings must be identical.

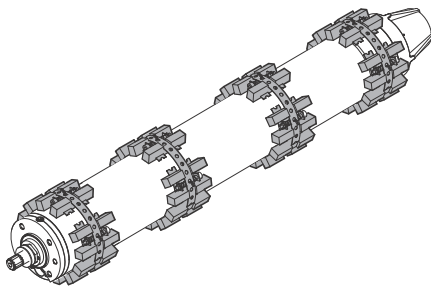

TIM05 0537 1211

Fig. 6 More than two anode strings

Maintenance

Anode life

The life of a zinc anode is 1 to 4 years, depending on the operating conditions (temperature, flow, content of chloride, etc.).

Inspection

Inspections must be made at regular intervals in order to ensure the functioning of the galvanic cathodic protection system. The first inspection must be made after six months and subsequently approximately once a year.

Precipitation

White and yellow corrosion products will build up on the anodes as these are reduced in size. Furthermore, a thin lime incrustation may build up on the pump. However, such precipitation is harmless.

Replacing the anode string

In order to ensure a good electric/metallic contact between clamp and pump/motor, the surface must be cleaned thoroughly before a new anode string is fitted.

Anode strings on pumps

The following sections show the number of anode strings required per pump and the corresponding product numbers.

DOL = Direct-On-Line starting.

SD = Start-Delta starting.

Product range

The following sections show the number of anode strings required per pump and the corresponding product numbers.

DOL = Direct-On-Line starting.

SD = Start-Delta starting.

SQF

SQF			
Pump stages	Number of anode strings	Product number	
		Anode string, DOL	Anode string, SD
2-7	2	97645697	-

SP1A

SP1A			
Pump stages	Number of anode strings	Product number	
		Anode string, DOL	Anode string, SD
3-36	1	993226959	---
37-57	2		

SP2A

SP2A			
Pump stages	Number of anode strings	Product number	
		Anode string, DOL	Anode string, SD
3-23	1	99326959	99326959
24-55	2		
39 - 60	3		

SP3A

SP3A			
Pump stages	Number of anode strings	Product number	
		Anode string, DOL	Anode string, SD
6 - 15	1	99326959	-
18 - 33	2		
56-60	3		

SP5A

SP5A			
Pump stages	Number of anode strings	Product number	
		Anode string, DOL	Anode string, SD
4 - 21	1	99326959	99326959
25 - 38	2		
44 - 60	3		
52 - 75	4		

SP7/ SP9

SP7 / SP98A			
Pump stages	Number of anode strings	Product number	
		Anode string, DOL	Anode string, SD
1 - 7	1	99326959	99326959
8 - 12	2		
13 - 25	3		
26 - 33	4		
34 - 42	5		
43 - 52	6		
53 - 59	7		

SP11/ SP14

SP11 / SP1414A			
Pump stages	Number of anode strings	Product number	
		Anode string, DOL	Anode string, SD
1 - 6	1		
7 - 12	2		
13 - 18	3		
19 - 24	4	99326959	99326959
25 - 30	5		
31 - 37	6		

SP17

SP17			
Pump stages	Number of anode strings	Product number	
		Anode string, DOL	Anode string, SD
1 - 5	1		
6 - 13	2		
14 - 25	3		
26 - 35	4		
36 - 42	5	97645875	97645875

SP30

SP30			
Pump stages	Number of anode strings	Product number	
		Anode string, DOL	Anode string, SD
1 - 3	1		
4 - 9	2		
10 - 15	3		
16 - 22	4		
23 - 28	5		
29 - 34	6		
35 - 38	7	97645875	97645875

SP46

SP46			
Pump stages	Number of anode strings	Product number	
		Anode string, DOL	Anode string, SD
1 - 3	1		
4 - 8	2		
9 - 13	3		
14 - 18	4	97645875	97645910
19 - 23	5		
24 - 25	6		

SP60

SP60			
Pump stages	Number of anode strings	Product number	
		Anode string, DOL	Anode string, SD
1 - 3	1		
4 - 8	2		
9 - 13	3		
14 - 18	4	97645875	97645910
19 - 23	5		
24 - 25	6		

SP77

SP77			
Pump stages	Number of anode strings	Product number	
		Anode string, DOL	Anode string, SD
1	1		
2 - 5	2		
6 - 10	3		
11 - 14	4	97645914	97646114
15 - 18	5		
19 - 22	6		

SP95

SP95			
Pump stages	Number of anode strings	Product number	
		Anode string, DOL	Anode string, SD
1	1		
2 - 5	2		
6 - 10	3		
11 - 14	4	97645914	97646114
15 - 18	5		
19 - 22	6		

SP125

SP125			
Pump stages	Number of anode strings	Product number	
		Anode string, DOL	Anode string, SD
1	1		
2 - 4	2		
5 - 8	3		
9 - 11	4	97646116	97646117
12 - 14	5		
15 - 17	6		

SP160

SP160			
Pump stages	Number of anode strings	Product number	
		Anode string, DOL	Anode string, SD
1	1		
2 - 4	2		
5 - 8	3		
9 - 11	4	97646116	97746117
12 - 14	5		
15 - 17	6		

SP215

SP215			
Pump stages	Number of anode strings	Product number	
		Anode string, DOL	Anode string, SD
1	1		
2 - 3	2		
4 - 6	3	97646118	97646137
7 - 8	4		
9 - 11	5		

SPG 270

SPG 270			
Pump stages	Number of anode strings	Product number	
		Anode string, DOL	Anode string, SD
1 - 2	2		
3 - 4	3		
5 - 6	4	97646138	97762380
7 - 8	5		

SPG 300

SPG 300			
Pump stages	Number of anode strings	Product number	
		Anode string, DOL	Anode string, SD
1 - 2	2		
3 - 4	3		
5 - 6	4	97646138	97762380
7 - 8	5		

SPG 360

SPG 360			
Pump stages	Number of anode strings	Product number	
		Anode string, DOL	Anode string, SD
1 - 2	2		
3 - 4	3		
5 - 6	4	97646138	97762380
7 - 8	5		

Anode strings on motors

The table below shows the number of anode strings required per motor and the corresponding product numbers.

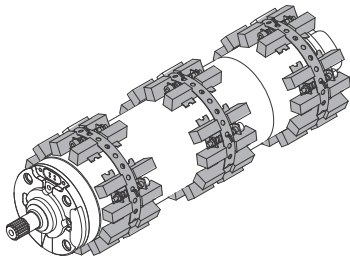

TM05 9668 0316

Fig. 7 Anode strings on MS motor

Zinc anodes for MS and MMS motors			
Motor	B = length [mm]	Number of anode strings	Product number
MS402 - MS4000" motor	Up to 350	2	96856060
MS402 - MS4000" motor	351 to 680	3	
MS402 - MS4000" motor	681 - 780	4	
MS 6000" motor	Up to 690	3	97645910
MS 6000" motor	691 - 975	4	
MS 6000" motor	976 - 1050	5	
MMS 6" motor	Up to 690	3	97645914
MMS 6" motor	691 - 975	4	
MMS 6" motor	976 - 1315	5	
MMS 6" motor	1316 - 1425	6	97646116
MMS 8" motor	Up to 1160	5	
MMS 8" motor	1161 - 1490	6	
MMS 8" motor	1491 - 2060	8	97646118
MMS 10" motor	Up to 1690	7	
MMS 10" motor	1691 - 2070	8	
MMS 10" motor	2071 - 2400	9	97646138
MMS 12" motor	Up to 1980	8	
MMS 12" motor	1981 - 2290	9	



TM06 6355 0316

Fig. 8 Length of motor

9. Cable sizing

Cables

Grundfos offers submersible drop cables for all applications: 4-core cable, single leads.

Cables for Grundfos 4" submersible motors are available with or without plugs. The submersible drop cable is chosen according to application and type of installation. See [Submersible drop cable](#) on page 15.

Tables indicating cable dimension in borehole

The tables indicate the maximum length of drop cables in metres from motor starter to pump at direct-on-line starting at different cable dimensions.

If star-delta starting is used, the current will be reduced by $\sqrt{3}$ ($I \times 0.58$), meaning that the cable length may be $\sqrt{3}$ longer ($L \times 1.73$) than indicated in the tables.

If, for example, the operating current is 10 % lower than the full-load current, the cable may be 10 % longer than indicated in the tables.

The calculation of the cable length is based on a maximum voltage drop of 1 % to 3 % of the rated voltage and a water temperature of maximum 30 °C.

In order to minimise operating losses, the cable cross-section may be increased compared to what is indicated in the tables. This is only economical if the borehole provides the necessary space, and if the operational time of the pump is long, especially if the operating voltage is below the rated voltage.

The table values are calculated on the basis of the formula:

Figure 9 consists of two tables. The top table is titled 'Voltage drop in %, for a one, three or four core flexible Grundfos drop cable' and 'CALCULATE GRUNDFOS DROP CABLE "VOLTAGE DROP" "Direct On Line"'. The bottom table is titled 'CALCULATE GRUNDFOS DROP CABLE "VOLTAGE DROP" "Start Delta"'. Both tables have columns for 'Rated voltage (U) in V' (230, 400) and 'Rated current (I) in A' (22, 33, 41, 55, 74, 99, 131, 182, 250, 330, 430, 567, 750). The y-axis represents 'Length of cable (L) in m' from 10 to 300. The tables are shaded to indicate different cable cross-sections (q) in mm².

Fig. 9 Cable sizing tool

Maximum cable length for a single-phase submersible pump:

$$L = \frac{U \times \Delta U}{I \times 2 \times 100 \times \left(\cos \varphi \times \frac{\rho}{q} + \sin \varphi \times X_L \right)} \quad [\text{m}]$$

Maximum cable length for a three-phase submersible pump:

$$L = \frac{U \times \Delta U}{I \times 1.73 \times 100 \times \left(\cos \varphi \times \frac{\rho}{q} + \sin \varphi \times X_L \right)} \quad [\text{m}]$$

Formula designations

U = Rated voltage [V]

ΔU = Voltage drop [%]

I = Rated current of the motor [A]

$\cos \varphi$ = Power factor

ρ = Specific resistance: 0.025 [$\Omega \text{ mm}^2$]

q = Cross-section of submersible drop cable [mm^2]

$\sin \varphi = \sqrt{1 - \cos^2 \varphi}$

X_L = Inductive resistance: 0.078×10^{-3} [Ω/m].

Example

Motor size: 30 kW, MMS 8000

Starting method: Direct on line

Rated voltage (U): 3 x 400 V, 50 Hz

Voltage drop (ΔU): 3 %

Rated current (I): 64.0 A

Power factor ($\cos \varphi$): 0.85

Specific resistance (ρ): 0.025

Cross-section (q): 25 mm^2

$\sin \varphi$: 0.54

Inductive resistance (X_L): 0.078×10^{-3} [Ω/m]

$$L = \frac{400 \times 3}{64.0 \times 1.73 \times 100 \times \left(0.85 \times \frac{0.025}{25} + 0.54 \times 0.078 \times 10^{-3} \right)}$$

L = 120 m.

Calculation of cable cross-section

Formula designations

U = Rated voltage [V]

ΔU = Voltage drop [%]

I = Rated current of the motor [A]

$\cos \varphi$ = Power factor

$\rho = 1/\chi$

Materials of cable:

Copper: $\chi = 40 \text{ m}/\Omega \times \text{mm}^2$

q = Cross-section [mm^2]

$\sin \varphi = \sqrt{1 - \cos^2 \varphi}$

X_L = Inductive resistance 0.078×10^{-3} [Ω/m]

L = Length of cable [m]

Δp = Power loss [W].

For calculation of the cross-section of the submersible drop cable, use this formula:

Direct on line

$$q = \frac{I \times 1.73 \times 100 \times L \times \rho \times \cos \varphi}{U \times \Delta U - (I \times 1.73 \times 100 \times L \times X_L \times \sin \varphi)}$$

Star-delta

$$q = \frac{I \times 100 \times L \times \rho \times \cos \varphi}{U \times \Delta U - (I \times 100 \times L \times X_L \times \sin \varphi)}$$

You can read the values of the rated current (I) and the power factor ($\cos \varphi$) in the tables on pages 46.

Calculation of the power loss

For calculation of the power loss in the submersible drop cable, use this formula:

$$\Delta p = \frac{3 \times L \times \rho \times I^2}{q}$$

Example

Motor size:	45 kW, MMS 8000
Voltage:	3 x 400 V, 50 Hz
Starting method:	Direct on line
Rated current (I_n):	96.5 A
Required cable length (L):	200 m
Water temperature:	30 °C.

Cable selection

Choice A: 3 x 150 mm².

Choice B: 3 x 185 mm².

Calculation of power loss

Choice A

$$\Delta p_A = \frac{3 \times L \times \rho \times I^2}{q}$$

$$\Delta p_A = \frac{3 \times 200 \times 0.02 \times 96.5^2}{150}$$

$$\Delta p_A = 745 \text{ W.}$$

Choice B

$$\Delta p_B = \frac{3 \times 200 \times 0.02 \times 96.5^2}{185}$$

$$\Delta p_B = 604 \text{ W.}$$

Savings

Operating hours/year: $h = 4000$.

Annual saving (A):

$$A = (\Delta p_A - \Delta p_B) \times h = (745 \text{ W} - 604 \text{ W}) \times 4000 = 564,000 \text{ Wh} = 564 \text{ kWh.}$$

By choosing the cable size 3 x 185 mm² instead of 3 x 150 mm², you achieve an annual saving of 564 kWh.

Operating time: 10 years.

Saving after 10 years (A_{10}):

$$A_{10} = A \times 10 = 564 \times 10 = 5640 \text{ kWh.}$$

You must calculate the saved amount in the local currency.

Cable dimensions at 3 x 400 V, 50 Hz, DOL

Voltage drop: 3 %

Motor	kW	I _n [A]	Cos φ 100 %	Dimensions [mm ²]																	
				1.5	2.5	4	6	10	16	25	35	50	70	95	120	150	185	240	300		
4"	0.37	1.4	0.64	462	767																
4"	0.55	2.2	0.64	294	488	777															
4"	0.75	2.3	0.72	250	416	662	987														
4"	1.1	3.4	0.72	169	281	448	668														
4"	1.5	4.2	0.75	132	219	348	520	857													
4"	2.2	5.5	0.82	92	153	244	364	602	951												
4"	3	7.85	0.77	69	114	182	271	447	705												
4"	4	9.6	0.8	54	90	143	214	353	557	853											
4"	5.5	13	0.81	39	66	104	156	258	407	624	855										
4"	7.5	18.8	0.78	28	47	75	112	185	291	445	609	841									
6"	4	9.2	0.82	55	91	146	218	359	566	867											
6"	5.5	13.6	0.77	40	66	105	157	258	407	622	850										
6"	7.5	17.6	0.8	29	49	78	117	193	304	465	637	882									
6"	9.2	21.8	0.81	23	39	62	93	154	243	372	510	706	950								
6"	11	24.8	0.83		34	53	80	132	209	320	440	610	823								
6"	13	30	0.81		28	45	68	112	176	270	370	513	690	893							
6"	15	34	0.82			39	59	97	154	236	324	449	604	783	947						
6"	18.5	42	0.81				48	80	126	193	265	366	493	638	770	914					
6"	22	48	0.84				41	67	107	164	225	313	422	549	665	793	927				
6"	26	57	0.84					57	90	138	189	263	355	462	560	667	781	937			
6"	30	66.5	0.83					49	78	119	164	227	307	398	482	574	670	803	926		
6"	37	85.5	0.79						63	97	133	183	246	317	382	452	525	624	714		
8"	22	48	0.84				41	67	107	164	225	313	422	549	665	793	927				
8"	26	56.5	0.85					57	90	138	189	263	356	464	563	672	787	947			
8"	30	64	0.85					50	79	122	167	233	314	409	497	593	695	836	968		
8"	37	78.5	0.85						65	99	136	190	256	334	405	483	567	682	789		
8"	45	96.5	0.82						54	83	114	158	213	276	334	396	462	553	636		
8"	55	114	0.85							68	94	131	177	230	279	333	390	469	544		
8"	63	132	0.83								83	115	155	201	243	289	338	404	466		
8"	75	152	0.86								70	97	132	171	208	249	292	353	409		
8"	92	186	0.86									79	107	140	170	204	239	288	335		
8"	110	224	0.87										89	116	141	169	198	240	279		
10"	75	156	0.84								69	96	130	169	205	244	285	343	396		
10"	92	194	0.82									79	106	137	166	197	230	275	316		
10"	110	228	0.84										89	116	140	167	195	234	271		
10"	132	270	0.84											98	118	141	165	198	229		
10"	147	315	0.81												103	122	142	169	194		
10"	170	365	0.81													105	122	146	168		
10"	190	425	0.79														106	125	144		
12"	147	305	0.83													105	125	146	175	202	
12"	170	345	0.85													92	110	129	155	180	
12"	190	390	0.84													98	114	137	158		
12"	220	445	0.85														100	120	139		
12"	250	505	0.85															106	123		
Max. current for cable [A]*				23	30	41	53	74	99	131	162	202	250	301	352	404	461	547	633		

* At particularly favourable heat dissipation conditions. Maximum cable length in metres from motor starter to pump.
For motors with star-delta starting, the cable length can be calculated by multiplying the relevant cable length from the above table by $\sqrt{3}$.

10. Table of head losses

Head losses in ordinary water pipes

Upper figures indicate the velocity of water in m/sec.

Lower figures indicate head loss in metres per 100 metres of straight pipes.

Quantity of water			Head losses in ordinary water pipes																
m ³ /h	Litres/min.	Litres/sec.	Nominal pipe diameter in inches and internal diameter in [mm]																
			1/2"	3/4"	1"	1 1/4"	1 1/2"	2"	2 1/2"	3"	3 1/2"	4"	5"	6"					
0.6	10	0.16	0.855 9.910	0.470 2.407	0.292 0.784														
0.9	15	0.25	1.282 20.11	0.705 4.862	0.438 1.570	0.249 0.416													
1.2	20	0.33	1.710 33.53	0.940 8.035	0.584 2.588	0.331 0.677	0.249 0.346												
1.5	25	0.42	2.138 49.93	1.174 11.91	0.730 3.834	0.415 1.004	0.312 0.510												
1.8	30	0.50	2.565 69.34	1.409 16.50	0.876 5.277	0.498 1.379	0.374 0.700	0.231 0.223											
2.1	35	0.58	2.993 91.54	1.644 21.75	1.022 6.949	0.581 1.811	0.436 0.914	0.269 0.291											
2.4	40	0.67		1.879 27.66	1.168 8.820	0.664 2.290	0.499 1.160	0.308 0.368											
3.0	50	0.83		2.349 41.40	1.460 13.14	0.830 3.403	0.623 1.719	0.385 0.544	0.229 0.159										
3.6	60	1.00		2.819 57.74	1.751 18.28	0.996 4.718	0.748 2.375	0.462 0.751	0.275 0.218										
4.2	70	1.12		3.288 76.49	2.043 24.18	1.162 6.231	0.873 3.132	0.539 0.988	0.321 0.287	0.231 0.131									
4.8	80	1.33		2.335 30.87	1.328 7.940	0.997 3.988	0.616 3.988	0.367 1.254	0.263 0.363	0.164									
5.4	90	1.50		2.627 38.30	1.494 9.828	1.122 4.927	0.693 4.927	0.413 1.551	0.269 0.203										
6.0	100	1.67		2.919 46.49	1.660 11.90	1.247 5.972	0.770 1.875	0.459 0.542	0.329 0.244	0.248 0.124									
7.5	125	2.08		3.649 70.41	2.075 17.93	1.558 8.967	0.962 2.802	0.574 0.809	0.412 0.365	0.310 0.185	0.241 0.101								
9.0	150	2.50		2.490 25.11	1.870 12.53	1.154 3.903	0.668 1.124	0.494 0.506	0.372 0.256	0.289 0.140									
10.5	175	2.92		2.904 33.32	2.182 16.66	1.347 5.179	0.803 1.488	0.576 0.670	0.434 0.338	0.337 0.184									
12	200	3.33		3.319 42.75	2.493 17.36	1.539 6.624	0.918 1.901	0.659 0.855	0.496 0.431	0.385 0.234	0.251 0.084								
15	250	4.17		4.149 64.86	3.117 21.36	1.924 6.624	1.147 1.901	0.823 1.282	0.620 0.646	0.481 0.350	0.314 0.126								
18	300	5.00			3.740 45.52	2.309 14.04	1.377 4.009	0.988 1.792	0.744 0.903	0.577 0.488	0.377 0.175	0.263 0.074							
24	400	6.67			4.987 78.17	3.078 24.04	1.836 6.828	1.317 3.053	0.992 1.530	0.770 0.829	0.502 0.294	0.351 0.124							
30	500	8.33				3.848 45.52	2.295 14.04	1.647 4.622	1.240 2.315	0.962 1.254	0.628 0.445	0.439 0.187							
36	600	10.0				4.618 51.84	2.753 14.62	1.976 6.505	1.488 3.261	1.155 1.757	0.753 0.623	0.526 0.260							
42	700	11.7				3.212 19.52	2.306 8.693	1.736 4.356	1.347 2.345	1.347 2.345	0.879 0.831	0.614 0.347							
48	800	13.3					3.671 25.20	2.635 11.18	1.984 5.582	1.540 3.009	1.005 1.066	0.702 0.445							
54	900	15.0					4.130 31.51	2.964 13.97	2.232 6.983	1.732 3.762	1.130 1.328	0.790 0.555							
60	1000	16.7					4.589 38.43	3.294 17.06	2.480 8.521	1.925 4.595	1.256 1.616	0.877 0.674							
75	1250	20.8						4.117 26.10	3.100 13.00	2.406 7.010	1.570 2.458	1.097 1.027							
90	1500	25.0						4.941 36.97	3.720 18.42	2.887 9.892	1.883 3.468	1.316 1.444							
105	1750	29.2						4.340 24.76	3.368 13.30	2.197 4.665	1.535 1.934								
120	2000	33.3						4.960 31.94	3.850 17.16	2.511 5.995	1.754 2.496								
150	2500	41.7							4.812 26.26	3.139 9.216	2.193 3.807								
180	3000	50.0								3.767 13.05	2.632 5.417								
240	4000	66.7									5.023 22.72	3.509 8.926							
300	5000	83.3										4.386 14.42							
			90° bends, slide valves	1.0	1.0	1.1	1.2	1.3	1.4	1.5	1.6	1.6	1.7	2.0	2.5				
			T-pieces, non-return valves	4.0	4.0	4.0	5.0	5.0	5.0	6.0	6.0	6.0	7.0	8.0	9.0				

The table is calculated in accordance with H. Lang's new formula $a = 0.02$ and for a water temperature of 10 °C. The head loss in bends, slide valves, T-pieces and non-return valves is equivalent to the metres of straight pipes stated in the last two lines of the table. To find the head loss in foot valves, multiply the loss in T-pieces by two.

Head losses in plastic pipes

Upper figures indicate the velocity of water in m/sec.

Lower figures indicate head loss in metres per 100 metres of straight pipes.

Quantity of water			PELM/PEH PN 10												
m ³ /h	Litres/min.	Litres/sec.	PELM					PEH							
			25	32	40	50	63	75	90	110	125	140	160	180	
			20.4	26.2	32.6	40.8	51.4	61.4	73.6	90.0	110	125	140	160	180
0.6	10	0.16	0.49 1.8	0.30 0.66	0.19 0.27	0.12 0.085									
0.9	15	0.25	0.76 4.0	0.46 1.14	0.3 0.6	0.19 0.18	0.12 0.63								
1.2	20	0.33	1.0 6.4	0.61 2.2	0.39 0.9	0.25 0.28	0.16 0.11								
1.5	25	0.42	1.3 10.0	0.78 3.5	0.5 1.4	0.32 0.43	0.2 0.17	0.14 0.074							
1.8	30	0.50	1.53 13.0	0.93 4.6	0.6 1.9	0.38 0.57	0.24 0.22	0.17 0.092							
2.1	35	0.58	1.77 16.0	1.08 6.0	0.69 2.0	0.44 0.70	0.28 0.27	0.2 0.12							
2.4	40	0.67	2.05 22.0	1.24 7.5	0.80 3.3	0.51 0.93	0.32 0.35	0.23 0.16	0.16 0.063						
3.0	50	0.83	2.54 37.0	1.54 11.0	0.99 4.8	0.63 1.40	0.4 0.50	0.28 0.22	0.2 0.09						
3.6	60	1.00	3.06 43.0	1.85 15.0	1.2 6.5	0.76 1.90	0.48 0.70	0.34 0.32	0.24 0.13	0.16 0.050					
4.2	70	1.12	3.43 50.0	2.08 18.0	1.34 8.0	0.86 2.50	0.54 0.83	0.38 0.38	0.26 0.17	0.18 0.068					
4.8	80	1.33		2.47 25.0	1.59 10.5	1.02 3.00	0.64 1.20	0.45 0.50	0.31 0.22	0.2 0.084					
5.4	90	1.50		2.78 30.0	1.8 12.0	1.15 3.50	0.72 1.30	0.51 0.57	0.35 0.26	0.24 0.092	0.18 0.05				
6.0	100	1.67		3.1 39.0	2.0 16.0	1.28 4.6	0.8 1.80	0.56 0.73	0.39 0.30	0.26 0.12	0.2 0.07				
7.5	125	2.08		3.86 50.0	2.49 24.0	1.59 6.6	1.00 2.50	0.70 1.10	0.49 0.50	0.33 0.18	0.25 0.10	0.20 0.055			
9.0	150	2.50		3.00 33.0	1.91 8.6	1.20 3.5	0.84 1.40	0.59 0.63	0.39 0.24	0.30 0.13	0.24 0.075				
10.5	175	2.92		3.5 38.0	2.23 11.0	1.41 4.3	0.99 1.80	0.69 0.78	0.46 0.30	0.36 0.18	0.28 0.09				
12	200	3.33		3.99 50.0	2.55 14.0	1.60 5.5	1.12 2.40	0.78 1.0	0.52 0.40	0.41 0.22	0.32 0.12	0.25 0.065			
15	250	4.17			3.19 21.0	2.01 8.0	1.41 3.70	0.98 1.50	0.66 0.57	0.51 0.34	0.40 0.18	0.31 0.105	0.25 0.06		
18	300	5.00			3.82 28.0	2.41 10.5	1.69 4.60	1.18 1.95	0.78 0.77	0.61 0.45	0.48 0.25	0.37 0.13	0.29 0.085		
24	400	6.67				3.21 19.0	2.25 8.0	1.57 3.60	1.05 1.40	0.81 0.78	0.65 0.44	0.50 0.23	0.39 0.15		
30	500	8.33				4.01 28.0	2.81 11.5	1.96 5.0	1.31 2.0	1.02 0.63	0.81 0.33	0.62 0.21	0.49 0.21		
36	600	10.0				4.82 37.0	3.38 15.0	2.35 6.6	1.57 2.60	1.22 1.50	0.97 0.82	0.74 0.45	0.59 0.28		
42	700	11.7				5.64 47.0	3.95 24.0	2.75 8.0	1.84 3.50	1.43 1.90	1.13 1.10	0.87 0.60	0.69 0.40		
48	800	13.3					4.49 26.0	3.13 11.0	2.09 4.5	1.62 2.60	1.29 1.40	0.99 0.81	0.78 0.48		
54	900	15.0					5.07 33.0	3.53 13.5	2.36 5.5	1.83 3.20	1.45 1.70	1.12 0.95	0.08 0.58		
60	1000	16.7					5.64 40.0	3.93 16.0	2.63 6.7	2.04 3.90	1.62 2.2	1.24 1.2	0.96 0.75		
75	1250	20.8						4.89 25.0	3.27 9.0	2.54 5.0	2.02 3.0	1.55 1.6	1.22 0.95		
90	1500	25.0						5.88 33.0	3.93 13.0	3.05 8.0	2.42 4.1	1.86 2.3	1.47 1.40		
105	1750	29.2						6.86 44.0	4.59 17.5	3.56 9.7	2.83 5.7	2.17 3.2	1.72 1.9		
120	2000	33.3							5.23 23.0	4.06 13.0	3.23 7.0	2.48 4.0	1.96 2.4		
150	2500	41.7							6.55 34.0	5.08 18.0	4.04 10.5	3.10 6.0	2.45 3.5		
180	3000	50.0							7.86 45.0	6.1 27.0	4.85 14.0	3.72 7.6	2.94 4.4		
240	4000	66.7								8.13 43.0	6.47 24.0	4.96 13.0	3.92 7.5		
300	5000	83.3									8.08 33.0	6.2 18.0	4.89 11.0		

The table is based on a nomogram.

Roughness: K = 0.01 mm.

Water temperature: t = 10 °C.

11. Grundfos Product Center

Online search and sizing tool to help you make the right choice.

<http://product-selection.grundfos.com>



"SIZING" enables you to size a pump based on entered data and selection choices.

"REPLACEMENT" enables you to find a replacement product. Search results will include information on the following:

- the lowest purchase price
- the lowest energy consumption
- the lowest total life cycle cost.

The screenshot shows the Grundfos Product Center website. At the top, there is a navigation bar with the logo and 'PRODUCT CENTER'. Below it are tabs for HOME, FIND PRODUCT, COMPARE, YOUR PROJECTS, SAVED ITEMS, and HELP. A search bar is prominently displayed with the text 'Input product number or a whole or partial product name'. Below the search bar are four main navigation buttons: SIZING (Enter pump sizing), CATALOGUE (Products and services), REPLACEMENT (Replace an old pump with a new), and LIQUIDS (Find pump by liquid). The 'QUICK SIZING' section includes input fields for 'Enter duty point' (Flow (Q)* in m³/h and Head (H)* in m) and 'Select what to size by' (radio buttons for Size by application, Size by pump design, and Size by pump family). A 'START SIZING' button is located to the right of these options. At the bottom of the screenshot, there are links for 'ADVANCED SIZING' with sub-options for 'Advanced sizing by application' and 'Guided selection'.

"CATALOGUE" gives you access to the Grundfos product catalogue.

"LIQUIDS" enables you to find pumps designed for aggressive, flammable or other special liquids.

All the information you need in one place

Performance curves, technical specifications, pictures, dimensional drawings, motor curves, wiring diagrams, spare parts, service kits, 3D drawings, documents, system parts. The Product Center displays any recent and saved items - including complete projects - right on the main page.

Downloads

On the product pages, you can download installation and operating instructions, data booklets, service instructions, etc. in PDF format.

Subject to alterations.

be think innovate

99077921

ECM: 1181413

GRUNDFOS A/S
DK-8850 Bjerringbro . Denmark
Telephone: +45 87 50 14 00
www.grundfos.com

GRUNDFOS 

© Copyright Grundfos Holding A/S

The name Grundfos, the Grundfos logo, and be think innovate are registered trademarks owned by Grundfos Holding A/S or Grundfos A/S, Denmark. All rights reserved worldwide.